

Quantum 2 25



Quantum 2 - Getting Started – Issue A

Issue A for Software Version 1400+

To be read in conjunction with the SD/QUANTUM Series Software Reference



EC DECLARATION OF CONFORMITY

This is to certify that the:

DIGICO QUANTUM 225 MIXING CONSOLE

Manufactured by:

**DIGICO (UK) LIMITED
UNIT 10
SILVERGLADE BUSINESS PARK
LEATHERHEAD ROAD
CHESSINGTON SURREY
KT9 2QL
UNITED KINGDOM
TEL: (++44) 01372 845 600
FAX: (++44) 01372 845 656**

Conforms with the protection requirements of the Council Directive's 2014/30/EU, 2014/35/EU and 2011/65/EU, relating to Electromagnetic Compatibility, Low Voltage Directive and the restriction of use of certain Hazardous Substances in Electrical and Electronic equipment Directive by the application of the following standards:

**EN55032 2015 Emission standard
EN55103-2 2009 Immunity standard
EN62368-1 2014 Safety requirements**

Signed: *John Stadius*
John Robert Stadius

Position: Technical Director

Date: 25TH FEBRUARY 2021

Quantum 2 - Getting Started – Issue A

Copyright © 2021 Digico UK Ltd

All rights reserved.

No part of this publication may be reproduced, transmitted, transcribed, stored in a retrieval system, or translated into any language in any form by any means without the written permission of Digico UK Ltd. Information in this manual is subject to change without notice and does not represent a commitment on the part of the vendor. Digico UK Ltd shall not be liable for any loss or damage whatsoever arising from the use of information or any error contained in this manual.

All repair and service of the QUANTUM 2 product should be undertaken by Digico UK Ltd or its authorised agents. Digico UK Ltd cannot accept any liability whatsoever for any loss or damage caused by service, maintenance, or repair by unauthorised personnel.

Software Licence Notice

Your license agreement with Digico UK Ltd, which is included with the QUANTUM 2 product, specifies the permitted and prohibited uses of the product. Any unauthorised duplication or use of Digico UK Ltd software, in whole or in part, in print or in any other storage and retrieval system is prohibited.

Licences and Trademarks

The QUANTUM 2 logo and QUANTUM 2 name are trademarks, and Digico UK Ltd and the Digico UK Ltd logo are registered trademarks of Digico UK Ltd. Microsoft is a registered trademark and Windows is a trademark of Microsoft Corp.

Digico (UK) Ltd
Unit 10
Silverglade Business Park
Leatherhead Road
Chessington
Surrey
KT9 2QL
England
Telephone: +44 (0)1372 845600
Fax: +44 (0)1372 845656
Email: sales@digiconsoles.com
WWW: <http://www.digico.biz>

Manual Issue and Date: Issue A – March 2021 – For Version 1400+

Licence Agreement

"**Product**": QUANTUM 2 software product produced by Digico UK Ltd is intended for use on Target Platform identified below.

"**Target Platform**": Digico QUANTUM 2 Digital Console system.

In return for the payment of the one-time fee, the Customer (identified at the end of this Agreement) receives from Digico UK Ltd a licence to use the Product subject to the following terms and conditions.

1. The Product may be used without time limit by the Customer on the Target Platform.
2. The Customer must register the Product with Digico UK Ltd. Registering the Product is deemed an acceptance of the terms and conditions in this agreement.
3. The Product and its licence are not transferable, and the Customer is not permitted to onward-license to any third party. The Customer indemnifies Digico UK Ltd against any and all claims and actions arising from third party use of copies of the Product made by the Customer.
4. The Customer agrees not to attempt to decompile the object code of the Product otherwise than in circumstances specifically provided for by law, and then only after consultation with Digico UK Ltd.
5. The Customer agrees not to use, or licence the Product for use, with equipment other than the Target Platform.
6. The Customer agrees not to modify the Product without the prior written consent of Digico UK Ltd.
7. This Agreement applies to any enhancement or upgrades that may become available for the Product.
8. This Agreement does not transfer any right, title, or interest in the Product to Customer except as specifically set forth herein.
9. Digico UK Ltd reserves the right to terminate this Agreement upon breach, in which event Customer shall thereafter only be authorised to use the Product to the extent that its contractual commitments to third parties require and then only where such commitments relate to use of the Product as authorised in the foregoing provisions of the Agreement.

LIMITED WARRANTY - Digico UK Ltd warrants for a period of 1 year from the date of purchase of the Product, the Product will reasonably execute its programming instructions when properly installed on the Target Platform. In the event that this Product fails to execute its programming instructions during the warranty period, the Customer's remedy shall be to return the Product to Digico UK Ltd for replacement or repair at Digico UK Ltd option. Digico UK Ltd makes no other express warranty, whether written or oral with respect of this Product.

LIMITATION OF LIABILITY - Except as otherwise expressly provided by law, (a) the remedies provided above are the Customer's sole and exclusive remedies and (b) Digico UK Ltd shall not be liable for any direct, indirect, special, incidental, or consequential damages (including lost profit whether based on warranty, contract, tort, or any other legal theory.)
This agreement is made under the Laws of England.

LICENCE NO:

REGISTRATION DATE:

Contents

The Console	1
1.1 Manual Overview	1
1.2 Before You Start	2
1.2.1 Worksurface Layout	2
1.2.2 Layers and Banks	4
1.2.3 Using the Control Surface	5
1.2.4 The Assigned Channel	6
1.2.5 The Master Fader	8
1.2.6 Channel Types	9
1.3 Hardware Configuration	10
1.3.1 Connections	10
1.4 Software Configuration	11
1.4.1 Templates	11
1.4.2 Session Structure Overview	11
1.4.3 Audio I/O Overview	12
1.4.4 Opto V221 (SD Racks)	13
1.4.5 Single SD Console System	13
1.4.6 Automatic Conforming	13
1.4.7 Manual Conforming of Racks	14
1.4.8 Rack Sharing	15
1.4.9 Assigning Faders to the Worksurface	15
1.5 Saving and Loading Sessions	16
1.5.1 Save As New File	16
1.5.2 Save Session	16
1.5.3 Load Session	16
1.6 Audio Sync	17
1.7 Routing Basics	18
1.7.1 Selecting Inputs & Outputs	18
1.7.2 Ripple Channels	19
1.7.3 Channel Names	20
1.8 Channel Processing	20
1.8.1 Dynamic EQ	20
1.8.2 Dynamics	21
1.9 Mustard Channels	22
1.9.1 Mustard Channel Strip	22

Quantum 2 - Getting Started – Issue A

1.9.2	Insert Position	22
1.9.3	Safes/Scopes	23
1.9.4	Presets	23
1.9.5	Pre-amplifier Modelling	23
1.9.6	Equaliser	24
1.9.7	Compressor	24
1.9.8	Gate/Ducker	25
1.10	Spice Rack.....	26
1.10.1	Chilli & Naga 6 Overview	26
1.10.2	User interaction options.....	28
1.10.3	Presets	29
1.11	Auxiliaries.....	30
1.12	The Matrix	31
1.13	Control Groups	32
1.14	Multi-channel formats	33
1.15	Solo Setup	34
DMI Cards.....		35
2.1	Fitting DMI Cards	35
2.2	DMI-MADI Cards	37
2.2.1	Connecting DMI-MADI	37
2.2.2	Sharing Racks with DMI-MADI.....	40
2.3	DMI - Dante Cards	42
2.4	DMI - ADC - DAC - MIC - AES Cards	44
2.5	DMI - Waves - Hydra Cards.....	45
2.6	DMI - ME - A3232 Cards.....	46
2.7	DMI – AMM	46
2.8	DMI-KLANG	50
2.9	DMI-Dante 64@96 & Dante IO Control.....	50
Quantum Home		53
3.1	Main Shortcuts.....	53
3.2	Settings Pane	54
3.3	System Information.....	55
3.4	Advanced Settings.....	56
3.5	Network Settings.....	58
3.6	Keyboard Shortcuts.....	58

The Console

The Digico QUANTUM 2 consists of a worksurface, an audio engine and a range of onboard inputs and outputs. This can be connected to multiple Input/Output Rack Units by optical fibre and/or MADI links, which carry all the audio input and output signals.

It also provides two DMI slots for the fitting of optional I/O cards and a "UBMADI" port.

NOTE: The UBMADI (USB AUDIO) port provides up to 48 I/O channels of audio when the console is running at either 48kHz or 96kHz via a USB connection. "UBMADI" runs at 48kHz irrespective of the console sample rate.

The console worksurface consists of 2 sections that can be configured to control up to 72 input channels, 12 Control Groups, 36 busses plus a Master buss (Stereo/LCR) and a 12 x 12 Matrix.

Each of the sections has 12 assignable faders and a set of assignable channel controls, the right section has an additional fader which is fully assignable but defaults to being assigned to the Master Buss.

The console's buss architecture is dynamic, and can support mono, stereo and LCR configurations.

Multiple console setups can provide:

Front of House and Monitoring with shared stage racks and gain tracking.

Remote control of one console from another console or from a laptop computer.

1.1 Manual Overview

This manual provides an overview of the desk and describes some of the basic operating principles which the user will need to understand in order to run the desk.

For full details on all Quantum/SD software functionality please refer to the Quantum/SD Series Software Reference Manual available for download at www.digico.biz



1.2 Before You Start

There are certain general operating principles and terms that should be understood before continuing to use this manual. Please read this chapter carefully before proceeding.

1.2.1 Worksurface Layout

Channel processing

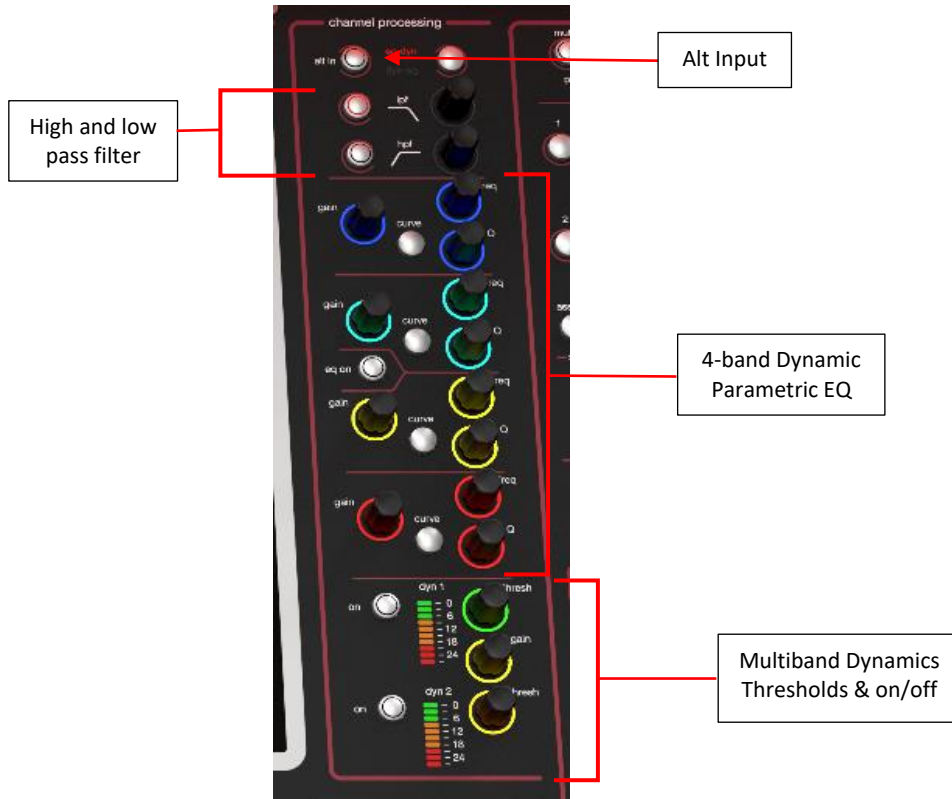

Master Section

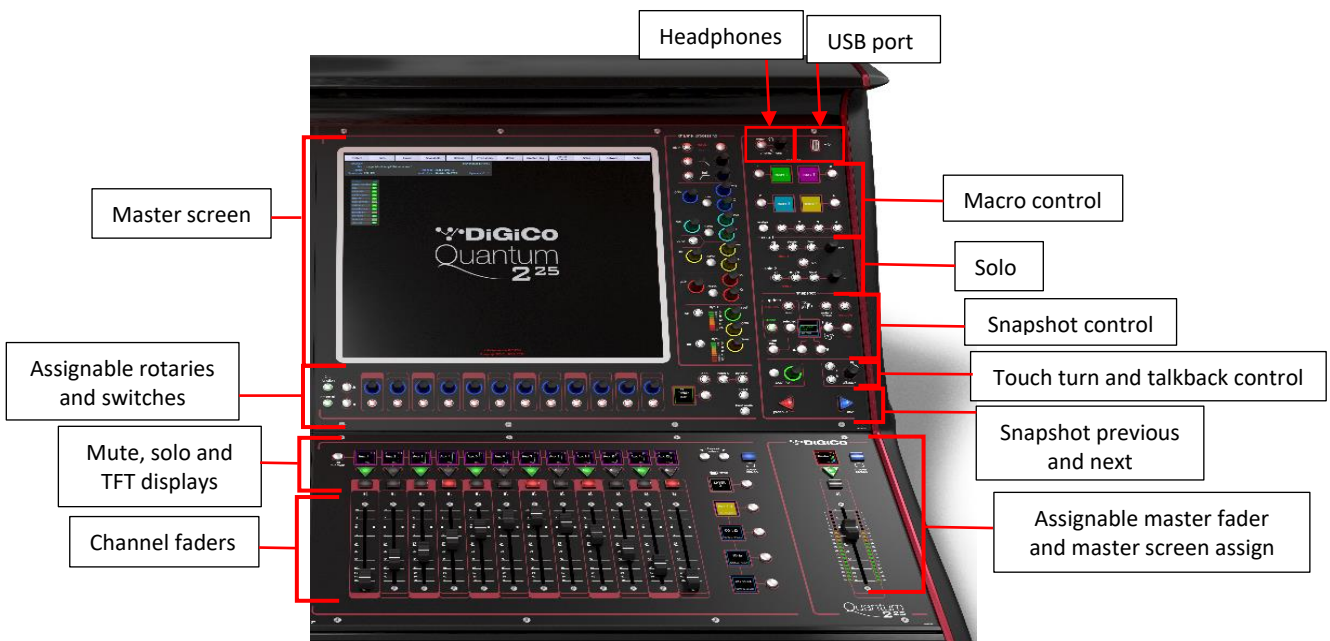

Rear Panel

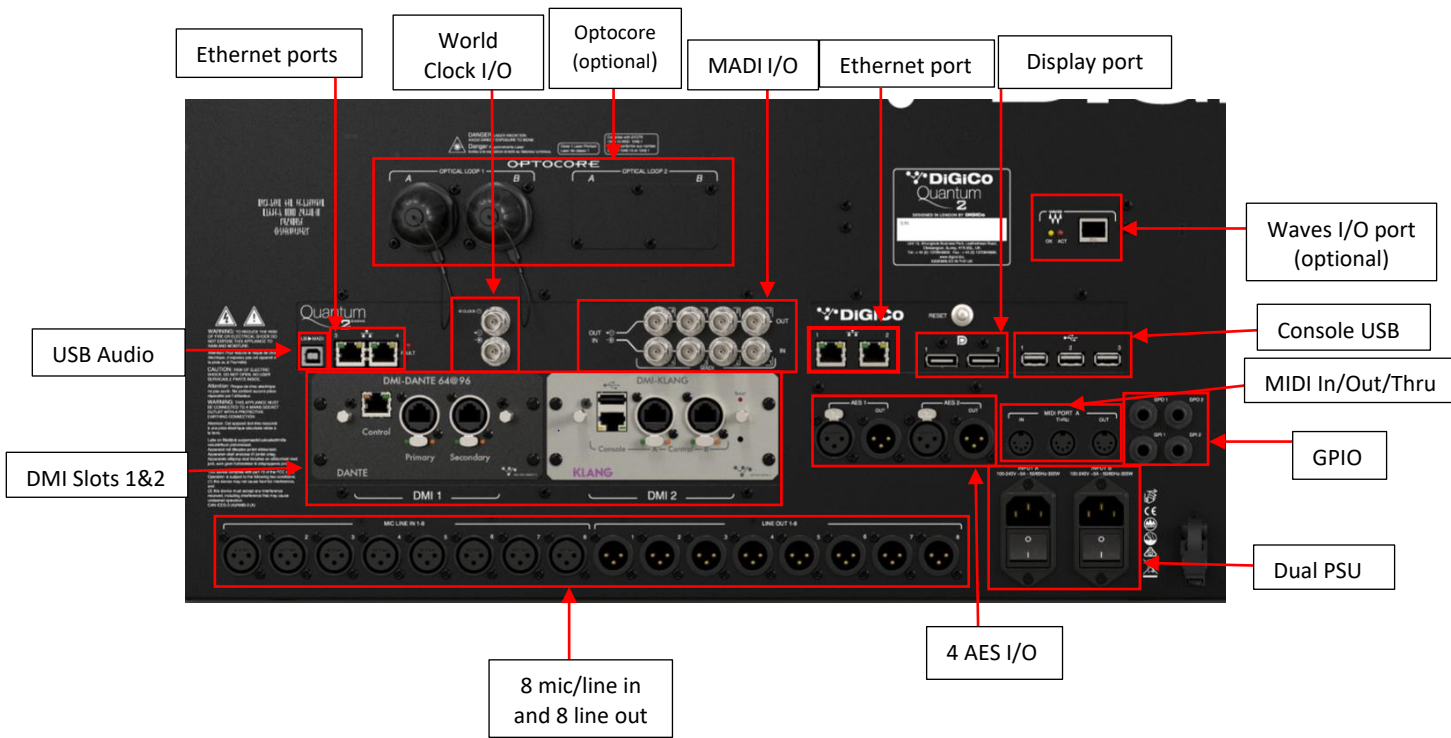

IP Addresses on a QUANTUM 2

The QUANTUM 2 Engine board contains 2 devices that require an IP address. The Console PC and the Host Interface controller. Both devices' IP addresses are displayed in the console diagnostics tab.

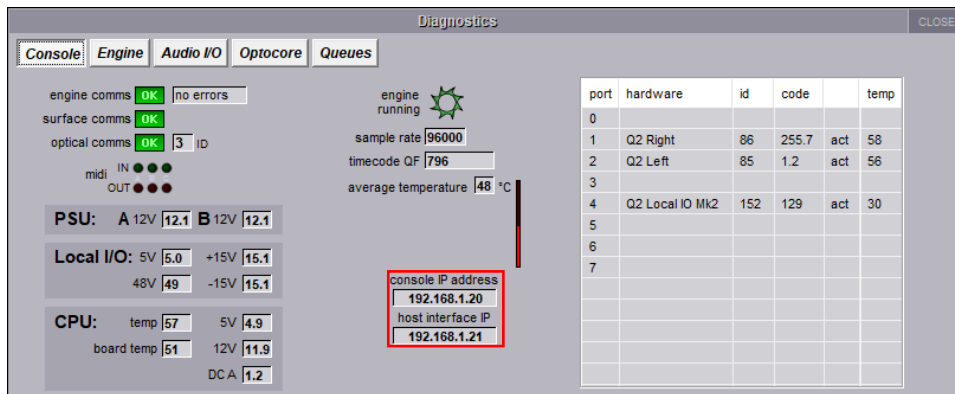

NOTE: This IP address will be set to appropriate values when the console is shipped and they should not be changed in normal operation.

The IP Addresses for these devices can however be set using Network Settings in the Quantum Home interface. Quantum Home can be accessed using the Master screen > System > Quit To Windows function.

This program allows the user to enter a single IP and subnet mask. This is the IP for the Console PC and the application will automatically set the Host Interface controller's IP to the correct sequential Address. Once the required IP or Subnet has been entered, a console power cycle is required for the change to take effect. Pressing the OK and Shut Down button will initiate the Shut Down Procedure.

1.2.2 Layers and Banks

The QUANTUM 2's worksurface is divided into Layers and Banks. Each Bank contains twelve channels, and the channels which are currently active on the control surface are defined using the **fader bank** and **bank layer** buttons to the right of the Channel Strip section's fader.

NOTE: There is also a Master Screen Assign button above the master fader on the centre section which is used to switch the right section to display the Master Screen.

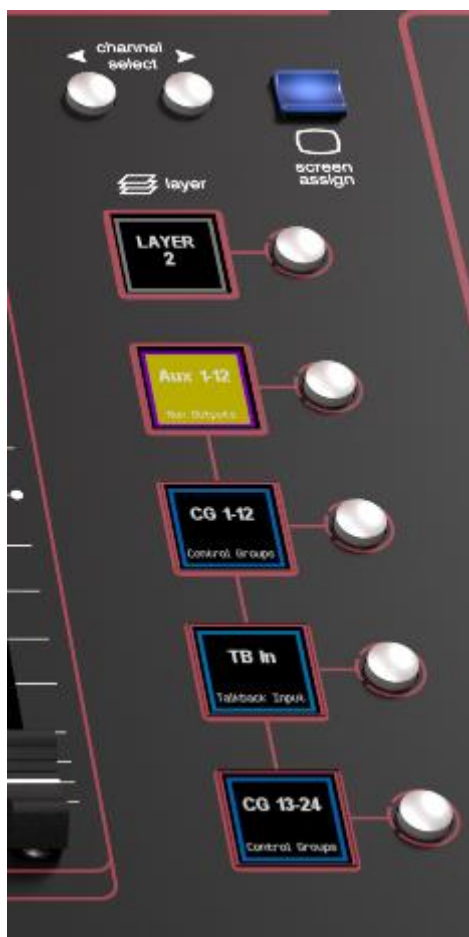

A 'bank' is a set of twelve faders, and a 'layer' contains up to four 'banks'. There are up to 3 'layers' in each section of the desk. Pressing the **bank layer** button, located above the **fader bank** buttons, toggles between layers.

To access a bank of faders within that layer, press the appropriate **fader bank** button. To switch both sections of the console to the same bank level, press and hold one of the **fader bank** buttons.

The specific channels which are contained within each Bank are defined in the **Layout > Fader Banks** display. By default, the Input channels will be assigned to Layer 1 of the console. The different output channels will be assigned to Layer 2. Control Groups will be assigned to Layer 2. These bank assignments can be customised by the user and saved in a session at any time.

1.2.3 Using the Control Surface

There are two main ways in which all of the functions of the QUANTUM 2 are accessed:

1. The touchscreen display, which can be controlled directly using a finger, or by using the keyboard and mouse
2. The physical encoders, switches and faders.

A number of functions can be accessed in different ways, allowing users to operate the console using whichever interface they prefer. This manual will describe accessing on-screen functions by touching the screen directly and not by using the mouse.

All of the physical controls are described in full within the relevant section of the manual and many require no further introduction.

The Master screen has a row of grey buttons across the top, which are used to access a range of configuration displays. Pressing these buttons opens either a further drop-down sub-menu or a pop-up display. If a drop-down menu is opened, pressing on one of its entries will open a pop-up display. The buttons lighten to indicate that their sub-menu or pop-up display is open. A number of the buttons within each pop-up display generate further pop-ups.

Generally, buttons within the pop-ups are coloured grey when their function is inactive, switching to a colour when their function is active. Pressing on a text box opens a numeric or QWERTY keypad which can be operated directly by pressing the screen or via the console's external keyboard.

Pop-ups are closed by pressing the box in the top right-hand corner of the pop-up, marked **CLOSE** or **CANCEL** (or by pressing **CAN** on keypad pop-ups).

On the Right-hand panel is a single encoder marked Touch-Turn (shown below). This is used to access any rotary controls within the Master Screen. To assign the Touch-Turn encoder to a particular on-screen pot, touch the pot to be assigned. You will notice that a coloured ring appears around the on-screen pot, indicating that it is assigned to the Touch-Turn encoder. The colour of this ring is unique to that control and is also reflected in the base of the Touch-Turn encoder, providing further indication of which pot is currently assigned to it.



The **Master Screen** button on the right-hand section switches the right screen view from the Master Screen to the bank of channels which are selected in the right-hand section.

1.2.4 The Assigned Channel

One of the channels in the Channel Strip panel is displayed in gold, indicating that it is currently the Assigned Channel. This means that it has been assigned to the worksurface controls and can be configured in detail, as described below. To Assign a channel, touch anywhere in the channel on the screen (except the Aux Send area or the meters at the top of the screen).

Alternatively, use the **ch** left and right buttons at the bottom of the channel worksurface controls to scroll through the channels in the panel:



Note that these left and right arrows are duplicated in the channel Setup and Output displays.

Note also that the Channel List display provides another method for assigning a channel to the worksurface controls.

Once a channel is assigned, all of the controls for that channel which are not displayed within the channel strip itself can be accessed via secondary pop-ups, displayed by touching inside the relevant area of the channel. These pop-ups include controls such as input and output routing and signal processing parameters.

A number of the physical rotary encoders on the control surface can be assigned to different on-screen pots. In order to ensure that it is clear which function is assigned to which encoder, the assigned on-screen pot will have a coloured ring around it which will be reflected in the colour of the light around the base of the encoder on the control surface

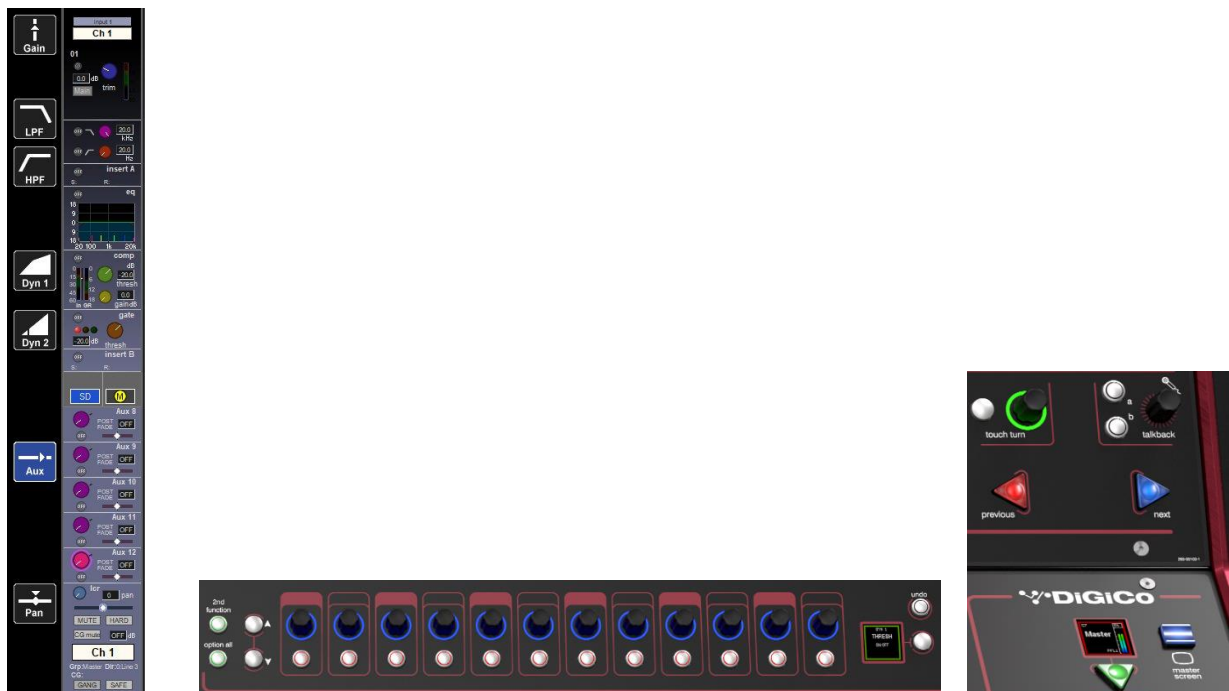

The row of twelve encoders and buttons immediately below the touchscreen (shown above) refer to the channels with which they are aligned.

Pressing one of the **Quick Select** buttons on the left of the screen will assign the selected function to the row of these controls below the screen. Five aux sends can be displayed in the Channel Strip panel at any one time. If more than six aux sends have been created in the session, the scroll button outside the bottom left-hand corner of the screen can be used to scroll the display through the remaining auxiliaries.

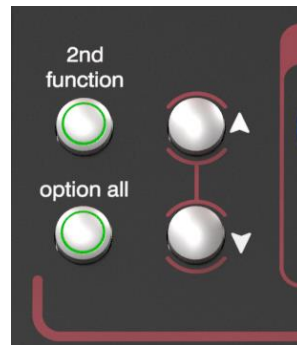

The controls to the right of the Channel Strip panel allow the Assigned channel to be adjusted:



The top half of the channel worksurface controls (down as far as the **insert a**, **insert b** and **direct** buttons, as shown above) control the signal processing parameters which are displayed in the pop-ups accessed by touching in the appropriate section of the active channel. The bottom half of the channel worksurface controls is concerned with output routing.

To the left of the screen are more channel controls: When pressed, the **2nd function** button allows access to different parameters:

- 1) Stereo Aux Pan and Pre/Post switching
- 2) Hard Mute of a channel
- 3) Switching of LR or LCR panning

2nd function is indicated by a green **2nd Function** display appearing in the bottom left-hand corner of the screen, as well as by the **2nd function** button lighting with a ring of green.



The **Option/All** button has 2 main functions:

- 1) When pressed and released, any channel that is a member of a gang or Multi will be temporarily isolated from that gang or Multi.
- 2) When pressed and held, any parameter that is adjusted on a single channel will also be adjusted in the same way on all of the channels in that bank

1.2.5 The Master Fader

By default, the fader in the bottom right corner of the right worksurface is assigned to the Master buss, which is the lowest numbered stereo group output by default.

In addition, this fader can be reassigned to control any input channel or buss of your choice using the **Layout>Fader Banks** panel

Press the **Assign master fader** button and the **Channel List** will be displayed.

Select a channel by touching its entry in the Channel List and it will be assigned to the Master Fader

The fader can also be unassigned (set to empty) by pressing the **Unassign master fader** button

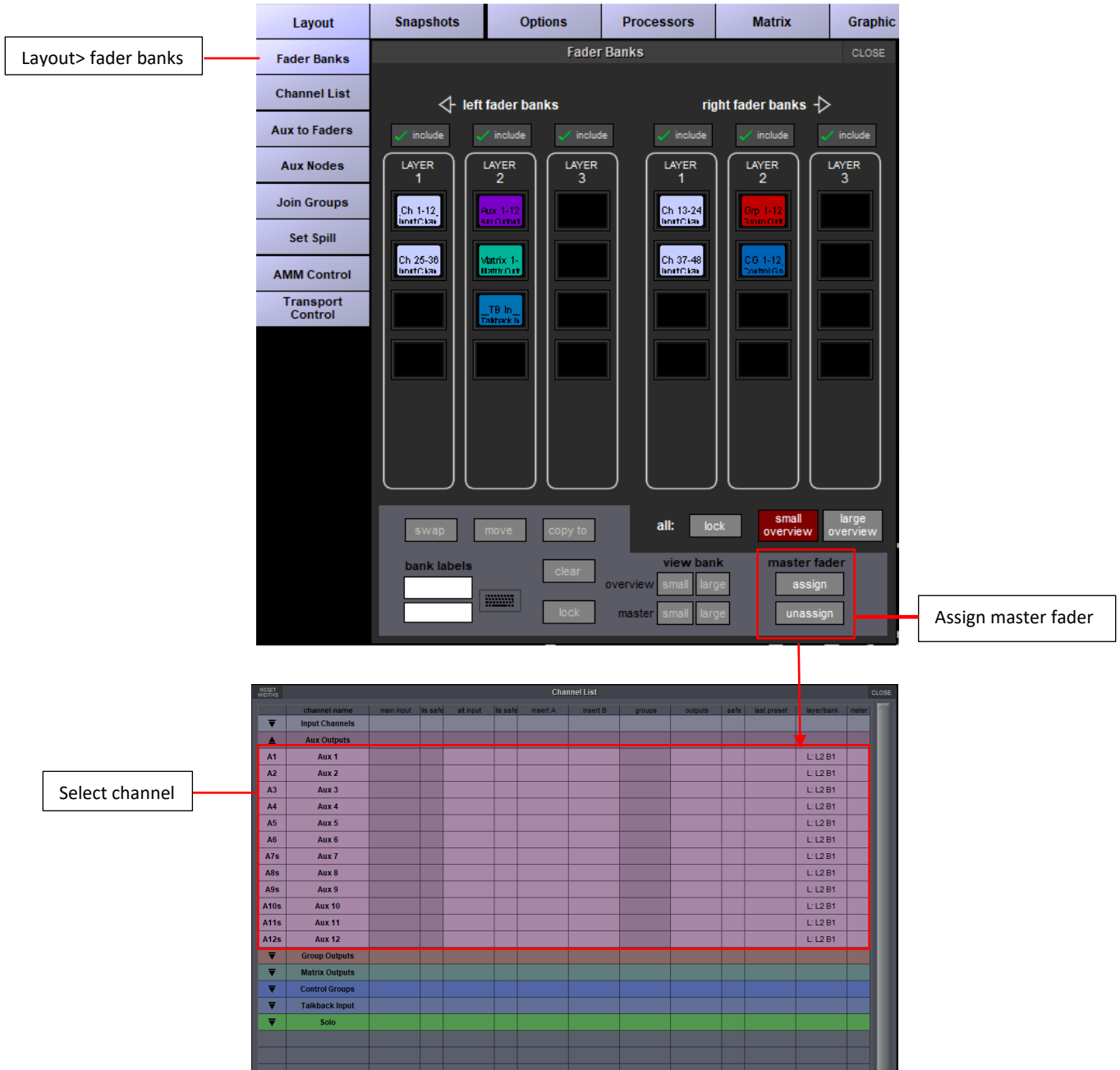

1.2.6 Channel Types

The QUANTUM 2 has 4 different channel types which are laid out in banks of 12 on the console worksurface and can be identified by their colour.

By default, the Input Channels will be assigned to Layer 1 on the left and right sections of the console.

The output channels (Groups, Auxes and Matrices) will be assigned to Layer 2.

Control Groups will be assigned to Layer 2. These bank assignments can be customised by the user and saved in a session at any time.

Holding any left or right section bank or layer button down for a couple of seconds will switch the left and right worksurface sections to the same bank level or layer.

The controls on each different type of output channel are identical but an input channel has a number of additional of features.

	Inputs	Groups	Auxes	Matrix
Input Module - Touch to Expand	01 0: Mic 1	G1	A1	M1
Analogue Gain/Digital Trim	0.0 dB	trim 0.0 dB	trim 0.0 dB	trim 0.0 dB
Phase - Gain Tracking	Main track	0.00 µs delay	0.00 µs delay	0.00 µs delay
Main/Alt Input Select	0.0 dB	0 samples	0 samples	0 samples
Delay				
HPF/LPF	20.0 kHz	eq bands 1-4	eq bands 1-4	eq bands 1-4
Insert A Routing & On/Off	insert A	insert A	insert A	insert A
4 Band Dynamic EQ	eq	eq	eq	eq
Touch To Expand				
Multiband Dynamics	comp	comp	comp	comp
Touch To Expand				
Insert B Routing & On/Off	insert B	insert B	insert B	insert B
SD/Mustard Display Switch	SD M	SD M	SD M	SD M
Aux Sends	Aux 8-12	aux sends		
Touch to Assign Row				
Channel Pan	pan	fx output	fx output	fx output
Mute Indicators	MUTE HARD	MUTE HARD	MUTE HARD	MUTE HARD
Channel Label	0: Mic 1	Grp 1	Aux 1	Matrix 1
Routing Module - Touch to Expand	Grp Master Dir: 0 Line 3	Out: CG:	Out: CG:	Out: CG:
Gang & Safe Indicators	GANG SAFE	GANG SAFE	GANG SAFE	GANG SAFE

1.3 Hardware Configuration

1.3.1 Connections

Detailed information on the various systems of connection is provided in the relevant chapter of this and the "Software Reference" manual but the following diagram provides an overview of a single console/single rack setup

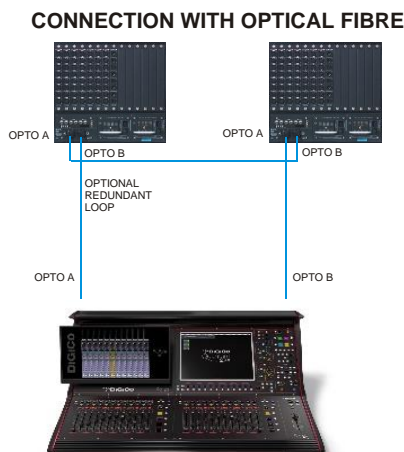
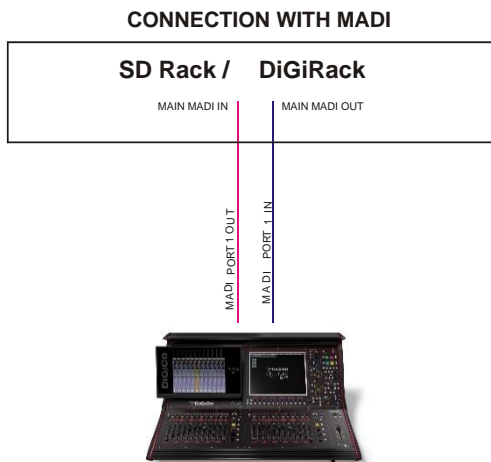

All connections should be made before switching on the console and racks.

The console and rack each have dual redundant power supplies and both should be switched on at all times. After switching on the console the software will be launched automatically and the state of the worksurface and settings should be the same as when it was last Shut Down.

To Shut Down the console press the **System > Shut Down** button and wait until you receive a message saying that it is safe to switch the power off.

The QUANTUM 2 worksurface has 8 analogue I/O and 4 AES Inputs (2 pairs) and 4 AES Outputs (2 pairs) on its rear panel (referred to as Local I/O) and additional I/O is supplied in the form of remote Racks which can each accommodate up to 56 inputs and 56 outputs in different formats. These racks are connected to the worksurface by either 100M high specification 75 Ohm coaxial cables fitted with BNC connectors or optical fibre. The Racks have two pairs of MADI connectors - Main MADI IN & OUT and AUX MADI IN & OUT.

In normal operation the MADI connections should be as follows (see diagram above):

- Rack MAIN MADI IN connected to the console MADI 1 OUT
- Rack MAIN MADI OUT connected to the console MADI 1 IN

Any of the console's other MADI Ports can be connected to a MADI recorder (See **Audio I/O Panel** for setup details) or a second DiGiCo Rack or console.

1.4 Software Configuration

The QUANTUM 2 has a default setup which means that the new user need not get involved in configuring the desk at this stage. However, here is a brief overview of how the different displays are used in putting together a session. Each of the master displays introduced below are described fully within the rest of the manual.

The **Files > Templates** display is used for loading pre-configured session templates.

The **Files > Session Structure** display is used for configuring how the console’s audio channels are to be divided between channel types, and where the format of the channels is defined

The **Session Structure** display can be used to automatically assign the channels to the worksurface. However, channels can also be manually added to the worksurface using the **Layout > Channel List** display.

The **Setup > Audio IO** display is used to configure the physical I/O connected to the QUANTUM 2, including configuring and naming the sockets of the option cards installed in racks, and the setting of pads and phantom power.

1.4.1 Templates

If any templates have been created, they provide an easy starting point for sessions which are already customised to your context. To load a session template, open the **Session Templates** display by selecting the **Templates** option at the top of the **Files** menu. Now touch the template you wish to load from the list shown and press **OK**.

1.4.2 Session Structure Overview

When starting a new session from scratch, it is important to decide how many of each type of channel is required. While changes to session structure can be made once a session has been started, it is best to try and set these parameters before configuring the session. The structure will set items such as the number of input channels, the number and type of aux channels and group channels available

The screenshot shows the 'Session Structure' configuration interface. Callouts point to the following elements:

- Enter session title:** Points to the 'session title' text field.
- Select session sample rate:** Points to the '48kHz' and '96kHz' buttons.
- Set number of input channels:** Points to the 'input channels' section with a value of 48.
- Set number of Aux busses:** Points to the 'aux busses' section with a value of 6.
- Set number of group busses:** Points to the 'group busses' section with a value of 6.
- Total number of unallocated processing:** Points to the 'spare: channel processing' field with a value of 24.
- Total number of spare busses:** Points to the 'busses' field with a value of 2.

Two sub-windows are also shown:

- Order of Aux Busses:** A table listing 12 aux buses with names (Aux 1-12) and widths (mono or stereo).
- Order of Group Busses:** A table listing 12 group buses with names (Grp 1-11, Master) and widths (mono, stereo, LCR, or 5.1).

Begin by setting the sample rate at the top of the panel. There is a total of 72 input channels available and 36 busses (plus a Master buss which can be stereo or LCR).

Channel resources can be split into input or output channels in almost any configuration. The default configuration is : 48 input channels (Input channel formats are defined within each channel, not within the Session Structure)

- 6 Mono Aux busses & 6 Stereo Aux busses
- 6 Mono Group busses & 6 Stereo Group busses
- 12 Matrix Inputs and 12 Matrix Outputs
- 12 Control Groups

Note that a Talkback channel is also assigned to the control surface, though it isn't configurable within the Session Structure and is therefore not displayed there.

To adjust any of the channel allocations, touch on the associated channel count box, and either enter a number using the pop-up number keypad, or adjust using the assigned touch turn controller.

Clear All Buttons : When changing routing, you have the option of clearing any non-default routing or processing (EQ, dynamics etc) from the channels in the session. This is especially useful when restructuring an existing session to make a new session. The other 'clear' buttons in the display perform similar operations.

Aux Sends and Direct Sends : By toggling the state of the **Aux Sends** and **Direct Sends** Buttons in the **Input Channels** section, it is possible to change the default operation of the Aux Sends and Direct Sends. These functions toggle between "Post Fader", "Pre-Fader" and "Pre-Mute".

Aux Order and Group Order : The Aux Order and Group Order buttons open a second window, providing you with the ability to change the order of auxes and groups. By default, mono busses come first, followed by stereo busses. The Master buss is the first stereo buss, regardless of the order you place the busses in.

Auto-Route : The Auto-route functions automatically routes consecutive inputs for input channels, and consecutive outputs for busses. For example, auto-routing 72 inputs will route the first physical input (eg 1: Mic 1) to input channel 1, the second physical input (1: Mic 2) to input channel 2... until you either run out of inputs or channels. Auto-routes are as follows :

- Input Channels auto-route with physical inputs
- Aux, Group and Matrix Channels auto route to physical outputs
- Matrix Inputs auto-route with group outputs

NOTE : Auto-Routing can only be used in conjunction with the "Clear All" button.

Rebuild Banks : When changing the number of allocated channels in any section (input channels, busses etc), you can restructure the session without rebuilding banks, meaning that any additional channels you have allocated will not be "placed" on the worksurface, and need to be manually assigned to faders. If however, you restructure a session with **Rebuild Banks** (either **Horizontally** or **Vertically**) enabled, the worksurface will be built with all channels available on the worksurface in a default layout. Rebuilding horizontally will result in input channels being spread across the top layer of both sides of the console, using as many banks as required, with output channels being assigned to Layer 2. Rebuilding vertically will result in input channels being assigned to Layer 1 on the left side of the console, and output channels to Layer 1 on the right.

1.4.3 Audio I/O Overview

The Audio I/O window is used to configure the physical I/O connected to the QUANTUM 2, including configuring and naming the sockets of the option cards installed in racks, and the setting of Pads and phantom power.

Local I/O : The QUANTUM 2 provides local audio I/O on the rear of the console. These operate independently of connected racks, providing additional audio I/O.

To access the QUANTUM 2 Audio I/O Setup Touch "Setup" on the Master Screen, followed by "Audio I/O"

The Audio I/O window that opens is divided up into the following sections

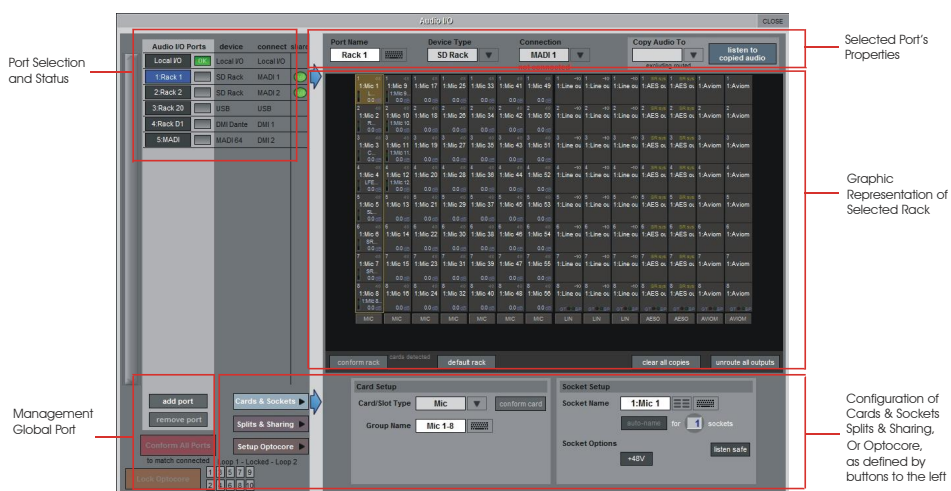

The top-left corner of the window shows the ports. Each port relates to an available physical audio connection (Local IO, IO Rack, or MADi Port, USB Audio (UBMADI), DMI cards). Ports can be added and removed using the buttons towards the bottom-left corner of the window.

NOTE: Please refer to the DMI card section of this document for more details on the use of DMI cards in the system

The top-right area contains the controls relating to specific ports. When a port is selected, this section changes to reflect the status of the selected port and allows its configuration to be changed as required.

Most of the right-hand section of the panel consists of a graphical representation of the rack configuration connected to the selected port. Depending on the port selected, the graphic will change, showing the available physical I/O. Each small “square” on the image represents a single physical audio connection or socket, with these arranged in columns or rows, representing I/O cards in racks, or the local I/O on the back of the console.

The section below the graphical rack picture allows configuration of either the cards or slots and sockets (including custom naming, phantom power and pad selection), or card splits and control sharing. The **Cards & Sockets** and **Splits & Sharing** buttons define which elements are displayed for configuration.

The local I/O configuration is fixed, so no hardware changes are possible. You can, however, change the Port Name, the Group Names (relating to the name of each physical card) and the Socket Names (the name of each physical connector on a card).

1.4.4 Opto V221 (SD Racks)

IMPORTANT NOTE: The QUANTUM 2 can only use Optocore via the optional Optocore connections on the console itself. The QUANTUM 2 cannot use an Optocore DMI card to connect to an Optocore system

SD Series consoles can operate with either one of two different Optocore firmware versions - V220 and V221.

The Quantum Series can only operate with Optocore firmware version V221.

V220 is compatible with DiGiRacks and MiNiRacks and cannot be used with SD Racks or DRacks.

V221 is compatible with SD Racks, SD MiNiRacks, NaNoRacks and DRacks, and cannot be used with DiGiRacks and MiNiRacks.

Note: Any type of rack can be used with a Quantum Series console if it is connected with Coaxial BNC MADi irrespective of the Optocore version that the console is using.

Sessions that have been created using Optocore connected DiGiRacks and MiNiRacks can be used with SD Racks and DRacks but a procedure must be followed to achieve this.

Sessions created using Optocore connected SD Racks and DRacks can also be used with DiGiRacks and MiNiRacks but this also involves a “conversion” procedure.

Note: For detailed information on Optocore system setup please refer to the SD/Quantum Software Reference manual Appendix - DiGiCo Optocore V221 - For SD Rack Optocore Operation

1.4.5 Single SD Console System

On a QUANTUM 2, go to Setup > Audio I/O. Press the Setup Optocore button and the Single Console button will be shown with a bright red background. Press this button, press Yes at the confirmation stage and the console will create ports for all connected racks, allocate all output cards to your console and create the Optocore map. The system is now ready to use.

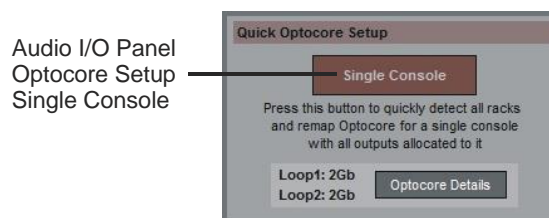

1.4.6 Automatic Conforming

Once all hardware is connected, go to System/Diagnostics/Optocore. This will list all connected Optocore devices either SDeng (console engines) to SDRack (SD Rack or D Rack) by ID. If any expected devices are not listed, please check all physical connections, Optocore ID's and Fibre Speeds. Once all devices are present, close the Diagnostics panel.

Irrespective of the type of rack being used, the system needs to be conformed. This involves the console checking the type of racks connected and their I/O capability

There are three levels of automatic conforming:

- globally, using the red Conform All Ports button in the bottom left of the window;
- on a rack-by-rack basis, using the **conform rack** button just below the rack view section of the window;

- on a card-by-card basis, by selecting a socket from the card in the graphical display and using the **conform card** button next to the Card/Slot type button selector in the lower section of the window. (Note that the **Cards & Sockets** button towards the bottom-left should be selected)
 Pressing any of these buttons will correctly select the card types for the range in question. Once complete, all of the Card Labels beneath each slot should turn green.

1.4.7 Manual Conforming of Racks

With a Rack selected in the left-hand port selection list, the window will look something like the image below, depending on the cards installed in the connected rack. The graphic shows the 14 available card slots, 7 input & 7 output.

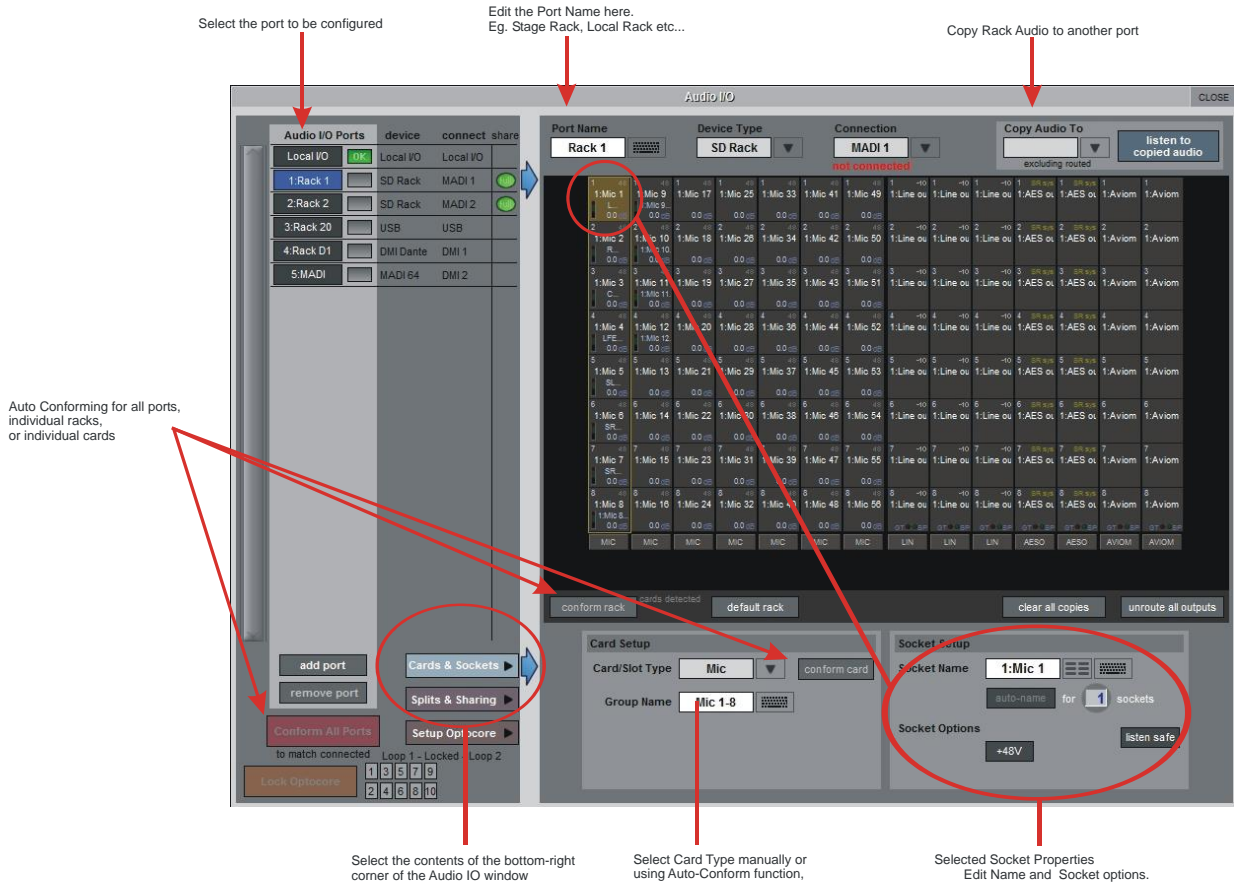

In order to use the rack, the on-screen contents of the rack must match the cards physically installed in the rack connected. This is normally achieved by pressing the **Conform All Ports** button but can also be achieved manually if necessary. Select each card (column) and manually select the appropriate card in the Card/Slot Type drop down menu in the lower section of the window (displayed when the **Cards & Sockets** button towards the bottom-left is selected). Once the correct card type is selected, the Label at the bottom the selected card will turn green, indicating the card type matches the card installed in the rack. If the Card Type name is Red, then there is a mismatch, and the error should be corrected by selecting the correct card type.

Copying Audio and Listening to Copied Audio (MADI Recorder Setup)

Audio from a Rack can be copied to the MADI Port Output by selecting the incoming Port in the Ports list and using the **Copy Audio To** drop down menu. For example, if you want to copy the Rack Audio Inputs to a recorder connected over MADI, select **Rack 1** in the ports list and then select **MADI** from the **Copy Audio To** drop down menu. The 56 inputs on Rack 1 will be copied to the QUANTUM 2 MADI output.
 In addition, by connecting the recorder's MADI Output to the QUANTUM 2 MADI Input, the playback can be monitored in the same channels as the original source material. Just press the **Listen To Copied Audio** button to monitor playback and press it again to return to monitoring the live sources from the rack

Standard MADI Connections

If you have a standard MADI connection (not a DiGiCo Rack) to your QUANTUM 2, you can set the console to display the MADI with generic signal names, i.e. MADI 1, MADI 2.. etc. through to MADI 56 (or 64) instead of the usual rack style names. The naming does not affect the signal, but makes routing signals easier.

Unrouting All Outputs

All outputs to the selected port can be unrouted at once by pressing the **unroute all outputs** button below the cards graphic and selecting **yes** in the warning pop-up which appears. "Copied" audio is not unrouted by this action.

Note that this will cancel all routing created in the channel screens and cannot be undone.

1.4.8 Rack Sharing

In a multi-console system where Racks are connected with MADI and shared between two DiGiCo Consoles, only one of the consoles can take control of the rack, with respect to Gain, Phantom Power and Pads. To overcome this, it is possible to place the QUANTUM 2 into one of 3 states of operation:

Isolate : The QUANTUM 2 will not communicate with the rack and therefore any adjustment of input gain or +48V switch will have no effect on the rack settings

Receive Only : The QUANTUM 2 will receive the rack's existing settings but will not be able to control the gain etc on the racks.

Full Control : The QUANTUM 2 will send its settings to the racks and change them accordingly.

Sharing is configured in the **Rack Sharing** area, found in bottom right-hand corner of the window when the **Splits & Sharing** button is selected:



These three states can be set on a per-rack basis (right column), or globally for all shared racks (left column).

1.4.9 Assigning Faders to the Worksurface

If, after a Session Restructure, you find that newly created channels do not appear on the worksurface, open the **Layout/Channel List** panel on the Master screen and you will see a full list of all input and output channels that are present in the session.

To assign channels to the worksurface, select a bank and press the **LCD Function** button.

Then press the LCD button labelled **Assign Faders** to enter that mode and press each of the LCD buttons for the channels that you wish to assign.

Now press the first channel that you wish to assign on the **Layout > Channel List** on the Master screen.

Consecutive channels will be assigned to the worksurface for each LCD button that is in Assign mode.

Now press the LCD Function button again and return to the standard mode by pressing the LCD button labelled **Solo**

*Note that column widths can be adjusted by dragging their borders within the title row. To return all columns to their default widths, press **RESET WIDTHS**, in the top left-hand corner of the window.*

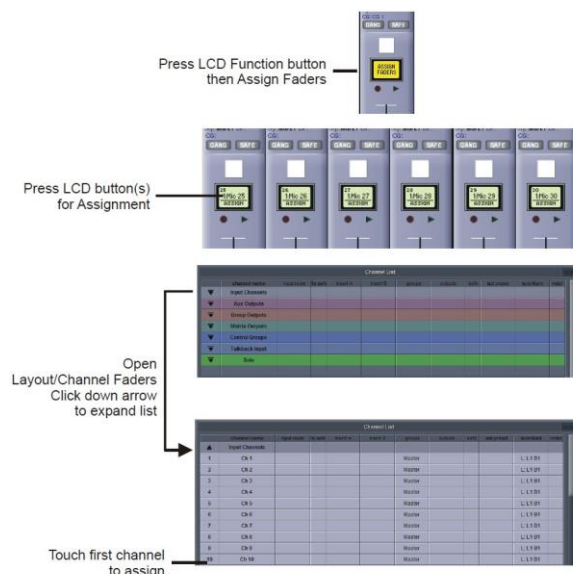

1.5 Saving and Loading Sessions

1.5.1 Save As New File

When you change the configuration of a session you should save it to the console's flash drive under a new filename. If the Save Session panel has not appeared automatically after a session restructure then touch the **Files** button on the Master screen and then press **Save As New File**. Select the destination drive (Internal or Removable) and file path and then enter a new file name and description for the file - then press the **Save** button.

Note: If you touch a session name on the existing list, this name will automatically be selected as the new file name and touching Save will overwrite the old file.

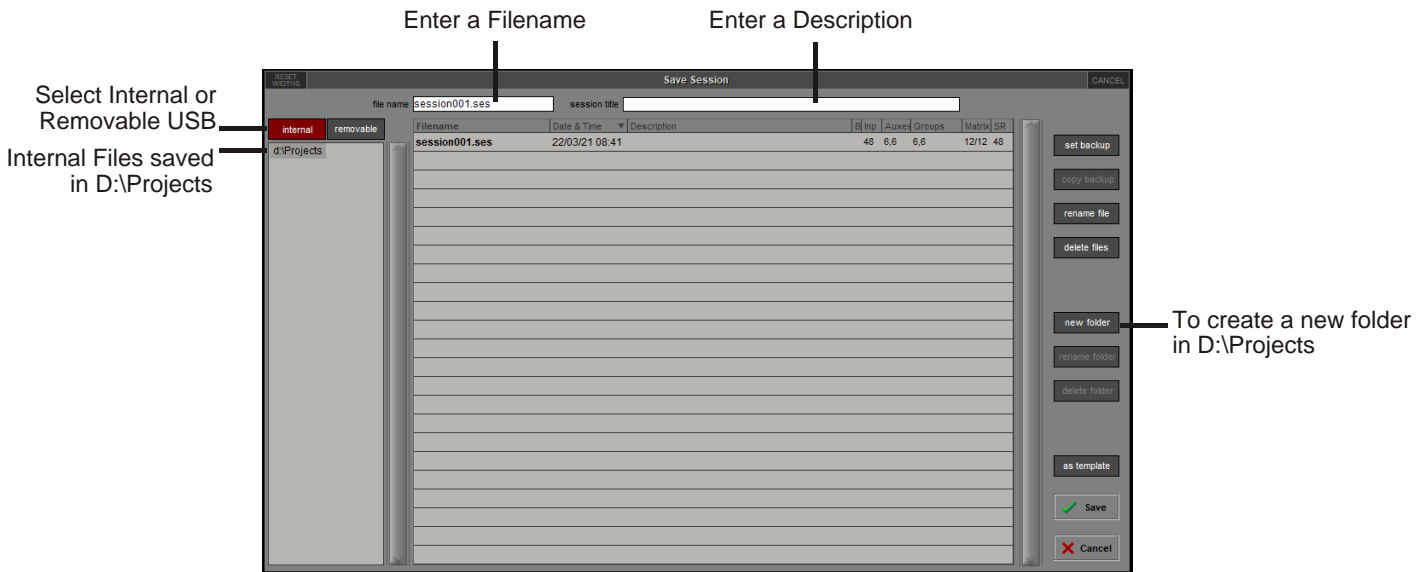

Note that column widths can be adjusted by dragging their borders within the title row. To return all columns to their default widths, press RESET WIDTHS, in the top left-hand corner of the window.

1.5.2 Save Session

This button which is found above the **Save As New File** button will save the existing session in the same location and under the same file name as it was previously saved or loaded from. It therefore serves as a "**Quick Save**" option to update an existing session.

Remember that this function will overwrite your last saved version.

If you wish to save the session under a new name use the **Files** menu button and select **Save As New File** (See above).

1.5.3 Load Session

To load a previously saved session:

Touch the **Files** button on the Master screen and then press **Load Session**.

Select the source drive (Internal or Removable) and the required file from the list - then press the **Load** button.

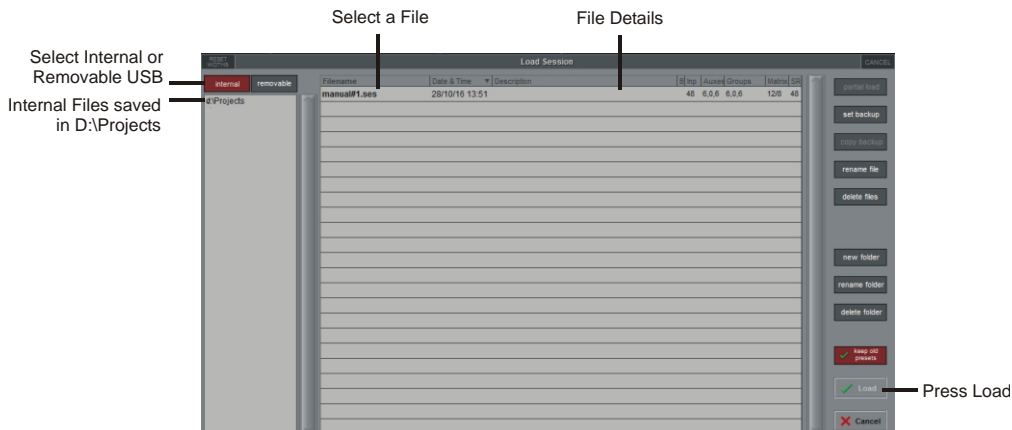

1.6 Audio Sync

To access the **Audio Sync** Panel, touch the **Setup** Menu button, followed by **Audio Sync**. The following window will open...

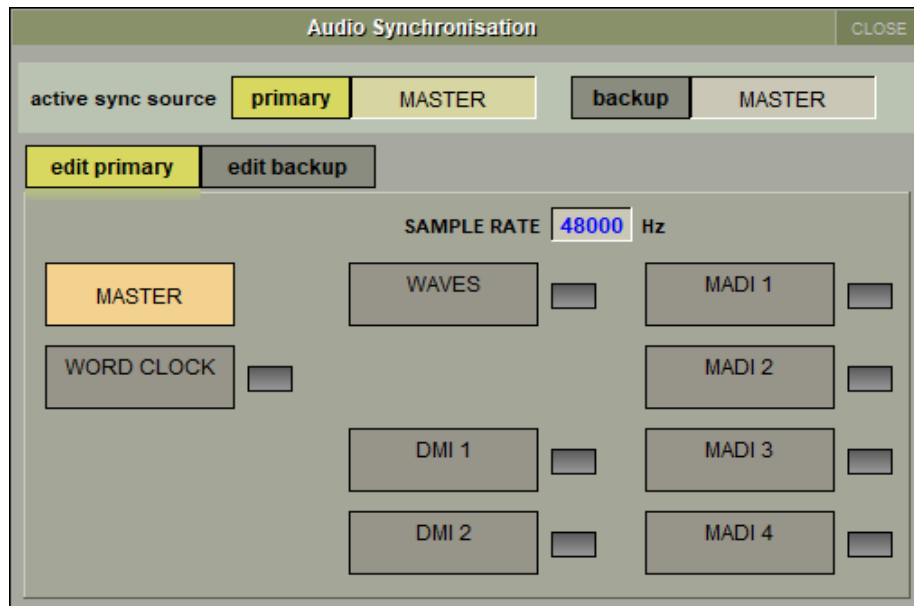

The QUANTUM 2 will operate at Sample Rates of either 48000Hz (48kHz) or 96000Hz (96kHz), as configured in the **Session Structure** panel.

By default, it is set to clock internally but, if Optocore is fitted, the standard Audio Sync method is Optocore when the entire system uses the device with the lowest Optocore ID (usually ID1) as its sync source.

This setting is saved within the session file so if any console(s) are connected to racks with optical fibre then all console engines should be set to Optocore as their sync source

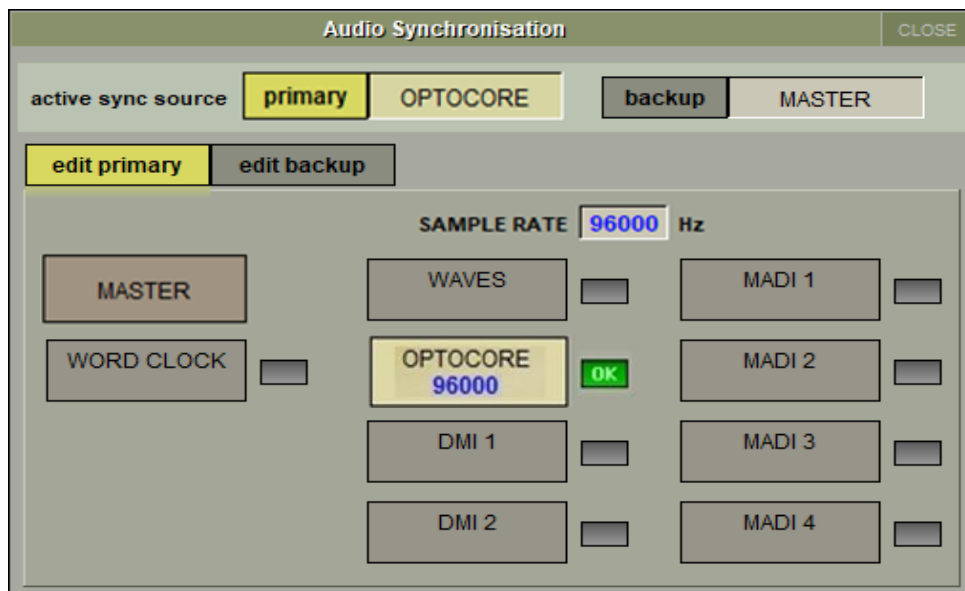

Example Clocking from Optocore@ 96kHz

There are also times when the QUANTUM 2 needs to be clocked externally. The Audio Sync panel allows you to control external synchronisation.

The QUANTUM 2 will clock from the following sources : Word Clock, Waves, MADI, Optocore and relevant DMI cards

In this situation one Optocore device should be set to clock to the external source and all other Optocore devices should be set to sync to Optocore.

Note : When a valid clock is detected on an external sync input, the corresponding Green OK box will light, even if that input is not selected as the clock source for the QUANTUM 2.

1.7 Routing Basics

1.7.1 Selecting Inputs & Outputs

All channel input, output, insert send and insert return routing is done via routing displays, accessed via the dark grey routing buttons in the channel **Setup** and **Output** displays (shown below for an Input channel's input).

Note that multi-channel signals are routed individually, and then collected together as a "Multi Channel" as described in the SD/Quantum Software Reference Manual

To access Channel Input Setup, touch the top of an input channel display on the touchscreen.

To access Channel Output Setup, touch the bottom of any channel type's display on the touchscreen.

It is also possible to configure channel input and output routing directly from the **Channel List** display: Activate the **Edit** button at the bottom of the display, then touch the input route box for a channel. A standard Setup display will then appear, from which a Routing display can be opened. Inserts and Outputs can also be routed from this display by touching in the appropriate column.

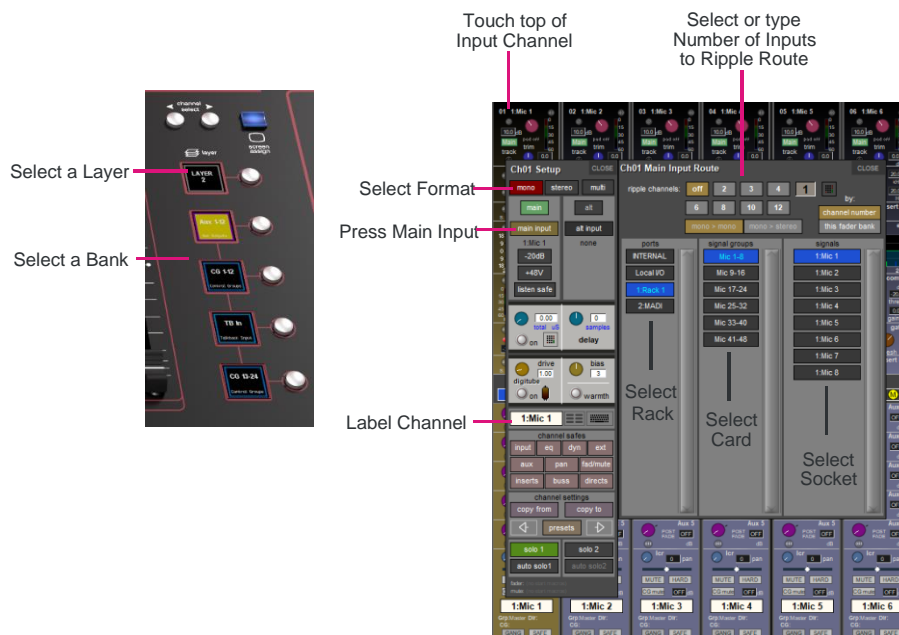

Within each display, there are three columns containing three levels of routing selection:

- The left-hand column contains the available **ports** within which the desired input or output might be located;
- The middle column, **signal groups**, then shows the available groups of inputs or outputs within that port;
- The right-hand column, **signals**, then displays the individual inputs or outputs available within that signal group.

The boxes in each column are lit blue to indicate that they are currently selected. If there is already a routing assigned within the display, the **port** and **signal group** columns containing the current assignment will be half-lit.

Each output can only have one channel routed to it. The outputs that are currently in use by another channel display in blue text. If you attempt to route a different channel to an output which is already in use, a confirmation box appears, indicating which channel is already using it, and warning that continuing with the action will cause the old channel to be unrouted from this output. Press **Yes** to proceed, **No** to cancel.

Note that when routing direct outs from Input channels or outputs from output channels, any number of available signals can be selected. A new route selection will therefore be added to previous selections in these cases. However, inputs, insert sends and insert returns can only route to/from one signal (in the case of mono channels) or two signals (in the case of stereo channels). A new route selection will therefore result in the previous selection being lost for inputs and insert sends and returns.

For stereo channels, left and right routes are presumed to be consecutive: When routing stereo signals, select the left route, and the next signal in the list will be automatically selected as the right route. If the last signal in a signal group or port is selected as the left route, the first signal in the following signal group or port will be selected as the right route.

For input and insert return routing, the **INTERNAL** port provides the following signal groups:

Misc:	The oscillator, white and pink noise generators.
Graphic EQs:	The outputs of the QUANTUM 2's internal graphic EQs.
Effects:	The outputs of any effects sends that have been created
Channels:	The direct outputs from the other input channels
Groups:	The outputs of the group busses
Auxes:	The outputs of the auxiliary busses
Matrix:	The outputs of the matrix busses.
Solos:	The outputs of the Solo busses

Note: The outputs for the channel being routed are locked out of the signal list

Note also that the console views all routes as a single list. Therefore, if the left signal is connected to the last signal in a port, the right signal, will be automatically connected to the first signal of the next port, regardless of port type.

For output and insert send routing, the **INTERNAL** port provides access to the inputs of the QUANTUM 2's Graphic EQs, and the inputs to any effects that have been created.

The **0:Local I/O** port contains a list of the inputs or outputs found directly on the QUANTUM 2's back panel.

The **Rack** ports contain all of the inputs or outputs available within the remote I/O racks, as defined in the **Audio I/O** display

Once a route has been selected, its name will appear below the routing button in the **Setup** or **Outputs** display.

Whenever a route is created, metering and additional controls are made available below the routing button. These controls are dependent on the type of route created.

Line input routed to an input or insert return:	an analogue gain control.						
Mic pre-amp routed to a mono input:	an analogue gain control and a 48V button for remote control of rack functions.						
Mic pre-amp routed to a stereo input:	an analogue gain control and a 48V button for remote control of rack functions.						
Mic pre-amp routed to an insert return:	an analogue gain control, a 48V button and a phase reverse button.						
Output routed to a console output:	a -10db pad (rack out only), on button for switching the send on and off, gain trim and send point selector which toggles the place within the channel from which the direct output is fed: <table style="margin-left: 40px;"> <tr> <td>pre-F</td> <td>Pre-fader,</td> </tr> <tr> <td>post</td> <td>Post-fader</td> </tr> <tr> <td>pre-M</td> <td>Pre-mute (and pre-fader)</td> </tr> </table>	pre-F	Pre-fader,	post	Post-fader	pre-M	Pre-mute (and pre-fader)
pre-F	Pre-fader,						
post	Post-fader						
pre-M	Pre-mute (and pre-fader)						
Insert send routed to a console output:	a -10db pad (rack out only), on button for switching the send on and off, and trim.						
Insert send routed to a graphic EQ:	an on button for switching the send on and off						
Output routed to a graphic EQ:	no additional control.						

Buttons become ringed in either red or green to indicate that they are on.

1.7.2 Ripple Channels

The **ripple channels** function, located at the top of the route display, allows consecutive channel routes to follow the routing of the current display incrementally. For example, Channels 1 to 8 direct outputs can be routed to Rack 1 > Line outs 1 to 8 respectively by routing Channel 1's direct out to Rack 1 > Line out 1 and allowing the **ripple channels** function to route Channels 2-8 automatically.

The number of channels to be rippled is defined either by selecting the appropriate grey numbered button, or by selecting the keyboard button to the right of the numbered buttons, typing the required number of channels (8 in the example above) into the numeric keypad which appears, and pressing **OK**. Once you have configured the **ripple channels** function, any routing action will also effect the appropriate number of channels above the channel being routed.

The **ripple channels** function treats stereo channels as two channels. In other words, if Channel 2 in the above example is stereo, the **ripple channels** function will route Channel 1 to Line out 1, Channel 2 Left and Right to Line outs 2 and 3, Channel 3 to Line out 4 etc.

The **Ripple by bank/ channel number** function changes how the channels are rippled, **Ripple by bank** ripples the channels by their position in the bank irrespective of channel number, **Ripple by Channel number** routes the rippled channels by channel number irrespective of position within the bank.

1.7.3 Channel Names

The black and white text box in the **Setup** display is used for naming the channel. Channel names are displayed in the scribble strip at the bottom of the screen. By default, the channel is given the same name as the selected input signal.

Note that if no input signal is selected, the scribble strip simply displays the channel number, prefixed by **ch** for Input channels, and prefixed by **Aux, Grp** or **Matrix** in the case of output channels.

The following notes are specific to naming channels:

The **Next** button moves the entire **Setup** display to the next channel.

At the very top of the channel, the channel number and input signal name are displayed for Input channels, and the channel type and number are displayed for output channels. These labels remain unchanged, regardless of any channel naming.

For Input channels, note that if the channel input signal is changed once a channel has been manually named, the channel name will no longer follow the input signal name. To reactivate the automatic channel naming function, clear the name and re-select the channel input.

*Note also that the channel **Output** display also provides access to this channel naming facility.*

Channels can also be named directly in the **Channel List** display (in the **Layout** menu). Open the display, activate the **Edit** function below the list, and expand the required channel type list by touching its row. Touching the **channel name** column for any channel in the list will cause a keyboard pop-up to appear, where a name can be typed in the usual way.

1.8 Channel Processing

1.8.1 Dynamic EQ

The EQ section comprises four user-configurable parametric filters with Dynamic Control on all Channels and a pair of swept High-pass and Low-pass filters.

The EQ is accessed by touching the on screen display to **Assign** the channel (**the colour changes to yellow**) and then using the controls on the right hand side of the input module.

When a control is adjusted the expanded view seen below appears on the screen. This view can be seen at any time by touching the EQ response graph on the screen.

NOTE: If the expanded view does not appear when a control is adjusted open the Options panel and set the Auto Expand EQ option to Yes

Each band's response can have one of two characters – precision and classic. These can be switched for all bands using the **precision** and **classic** buttons.

To access the Dynamic control, touch the left arrow symbol on any EQ band.

Touching the normal EQ response graph will show an expanded view in a separate panel.

The order of EQ and Dynamics in the channel signal path can be changed using the worksurface button at the bottom of the EQ section.

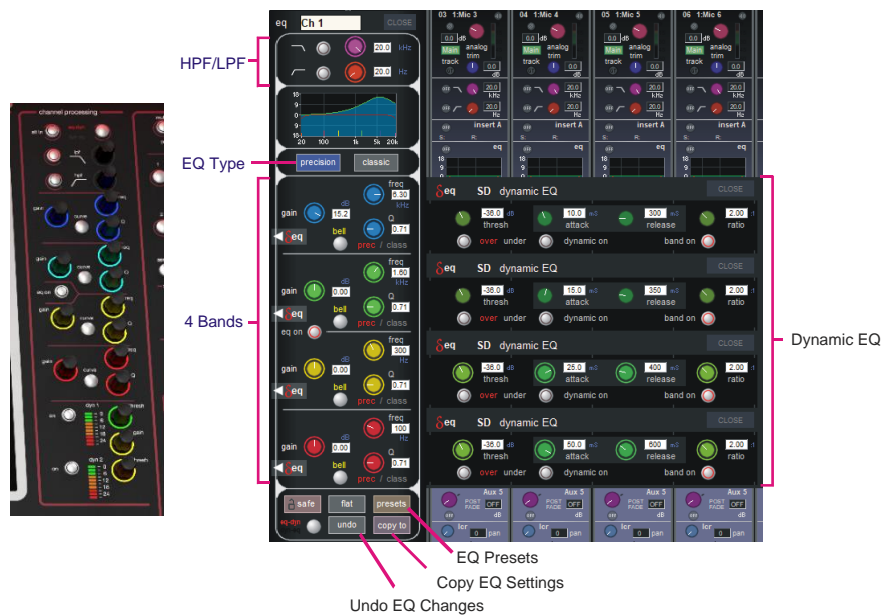

Note: The type of filter used on the top and bottom bands can be changed by successive presses of the Curve button for that band.

1.8.2 Dynamics

The dynamics are accessed by touching the words **Comp** or **Gate** just below the EQ graph on screen to open the dynamics panel. There are two dynamics modules, the first of which can function as a simple compressor, a 3 way multiband compressor, or a de-esser, according to the **comp/multi/desser** button to its left. The second (lower) module can function as a gate, a ducker or a compressor with an external sidechain, according to the **gate/duck/comp** button to its left. The worksurface controls beneath the screen control the various parameters. Touching the **Close** button in the top right corner of the panel will close it. The **Graph** button will display user configurable parameters that can be adjusted by screen touch and are shown in a graphical format. Dedicated **Threshold, Gain** controls and **In/Out** switches can be found on the right hand side of that section's worksurface. These can control the Assigned channel's dynamics whether the on-screen dynamics panel is open or not.



The **Assignable encoders and switches** beneath the screen can be assigned to any of the main dynamics controls. Hold the **Assign Switch** button on the right of the input section and touch the dynamics control required on the screen. The selected control is shown by the **Status Display**.

Multiband Compression is available on all channel dynamics modules. Click on the **dynamics mode select** button on the left of the display to access the 3 dynamics bands

Each band includes all of the parameters as those found in the single band compressor. The link function remains available for the whole compressor and is not assigned to any band. The bands can be switched on individually using the **on** buttons in the left-hand side of each band, or together using the **all on** button to the display's right.

The crossover frequency between bands is controlled using the purple and red pots to the left of the **hi** and **lo** bands. Each crossover has a range of 20Hz to 20kHz, and the crossover frequencies are displayed below each pot. Each band can be auditioned by pressing the **listen** button below each **gain** pot which solo's that band to the mix (not the solo buss), in effect temporarily switching off the other bands.

The channel strip's compressor threshold and gain controls adjustment all three bands' controls, maintaining any relative offsets. The individual controls are mapped to the assignable rotaries below the screen.

***Note:** Beyond the link function, the single and multi-band compressors have completely separate settings: No settings are copied between them, and the settings of each remain unchanged when the other is active.*

1.9 Mustard Channels

Mustard channels are a feature of Quantum engines and work alongside standard SD channel strip processing, with both being available at once.

Mustard provides a tube/preamp modelling section, an EQ, a compressor with four different models and a gate/ducker.

Up to 24 Mustard channel strips (Software V1400+) can be used across the console at any one time. A channel is counted as having Mustard processing active once any one of the Mustard modules are turned on.

When this is the case, the channel will display the 'Active' icon above the Mustard processing icon, as shown below.

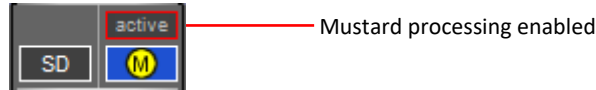

1.9.1 Mustard Channel Strip

The Mustard channel strip layout and operation is similar to that of the SD channel strip, as shown below.

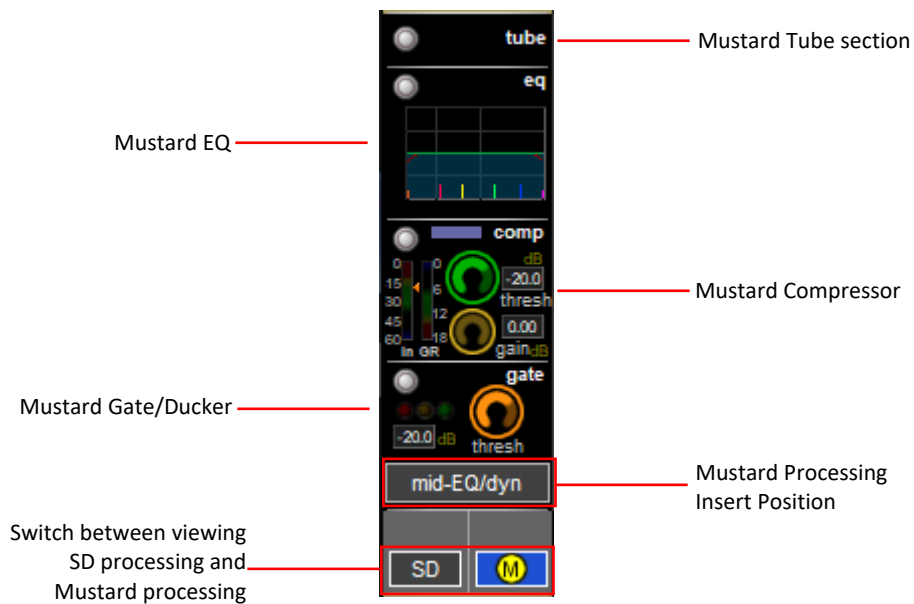

1.9.2 Insert Position

There are 5 selectable positions to choose from when enabling Mustard processing on a channel.

The default position for Mustard processing is between the EQ & Dynamics module (depending on the EQ/Dynamics order).

Two options will be unavailable as these are the locations of the channel's Insert A and Insert B. These insert positions can be selected for the Mustard processing by changing the location of Insert A/B, at which point they become available.

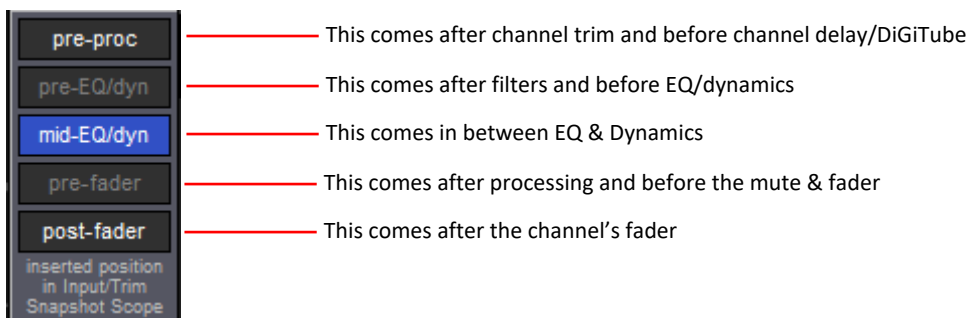

1.9.3 Safes/Scopes

Each Mustard module (tube, EQ, dynamics) can be safed individually with the tube safe including the insert position of the Mustard processing.

The global scopes follow SD processing with tube under input/trim, EQ under EQ and the compressor and gate under dynamics. Input/trim scope also includes the insert position of Mustard processing.

1.9.4 Presets

Channel presets can be created as normal and each Mustard module can be included or excluded in the recall scope.

Recalling a preset from within the view of a particular module will include only that module in the recall scope by default.

Similarly to channel safes, the insert position of the Mustard processing is included within the pre-amp scope.

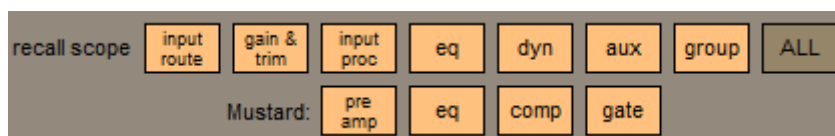

1.9.5 Pre-amplifier Modelling

The Mustard pre-amp modelling section provides the user with a choice of either a simple tube model or a more advanced pre-amp model. This is chosen by selecting **type**, where a menu will display with the two options.

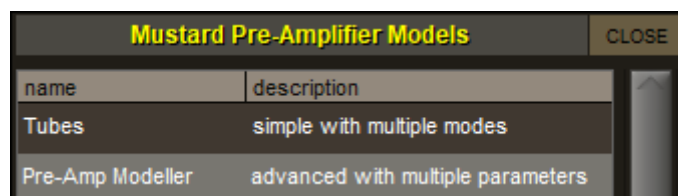

Mustard Tubes

Mustard Tubes has a **drive** control, an **output** gain control, an on/off button and six selectable preset options.



Odd harm – This is a modern sounding, low gain distortion preset

Even harm – This is a vintage sounding, medium gain distortion preset

Overdrive – This is modern sounding, medium gain distortion preset

Distortion - This is modern sounding, compressed, high gain distortion preset

Crunch – This is a vintage sounding, high gain distortion preset

High distortion – This is a modern, heavy sounding, very high gain distortion preset

Mustard Amp Model

The Mustard Amp Model is a two-stage, highly customisable distortion & overdrive processor.

Both stages can be switched to **odd** or **even** harmonics independently of each other. Even harmonics can create a triode-style distortion whereas odd harmonics can create a pentode-style distortion.

The **drive** control alters the input level to the first stage of distortion.

A **bias** control between the two stages can create asymmetrical distortion if desired. The midpoint value of 11 is the most transparent. Turning on the **'saturate'** option increases the effect of the bias setting.

There is a **high frequency boost** after both stages which applies a shelving boost above 6kHz. This is followed by the output gain.

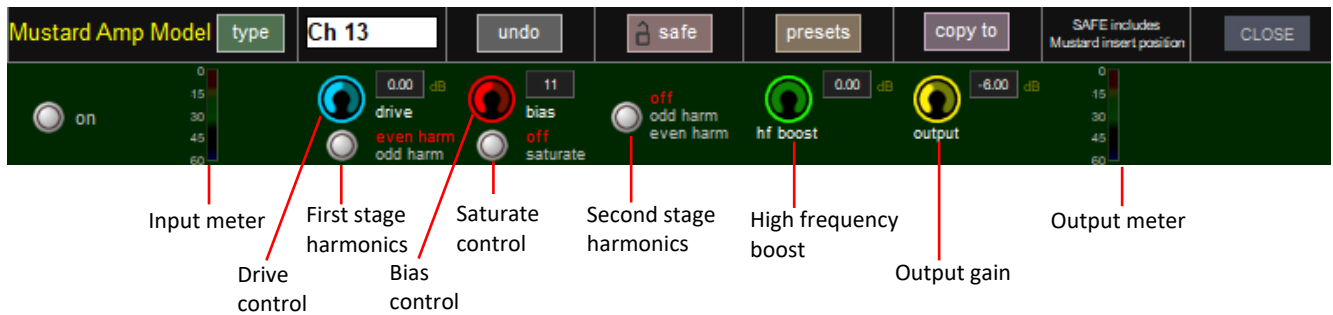

1.9.6 Equaliser

Mustard EQ operates in a similar manner to the standard SD channel EQ, with four fully parametric bands.

When used on a channel alongside the standard SD processing, this allows the user to have double the amount of fully parametric bands. The top and bottom bands can be switched to act as high and low shelf filters respectively, rather than bell. The middle two bands can be switched from bell filters to all-pass filters.

There are also high-pass and low-pass filters (both 24dB/8ve).

1.9.7 Compressor

The Mustard channel strip gives the user a choice of four different compressor models, which are modelled on classic analogue compressors.

All of the compressor types give the user an on/off button, a wet/dry **mix** knob, and an output **gain** control. Other controls vary depending on the type selected.

The **mix** knob controls the balance between the wet (compressed) audio and the dry (uncompressed) audio. If it is set to 100%, there will only be the compressed signal at the output.

On all but the Green FET Limiter, there is a **threshold** control, along with high and lowpass filters in the compressor's side chain controlled by the **low** and **high** rotaries. The effect of the filters on the sidechain signal can be monitored by pressing the **s/c listen** button.

An external sidechain, that is shared with the gate/ducker, can be used with the compressor by selecting a sidechain source in the box underneath the gate/ducker controls and then selecting to send it to the compressor sidechain.

Classic

The Mustard classic compressor is a general-purpose feed-forward compressor design with multiple controls allowing flexibility. The **threshold**, **attack** time, **release** time, and **ratio** can be all controlled by the user.

A **hard** or **soft** knee can also be selected, and the sidechain's amplitude sensing can be changed between **RMS** (Root Mean Squared) level and **peak** (instantaneous) level.

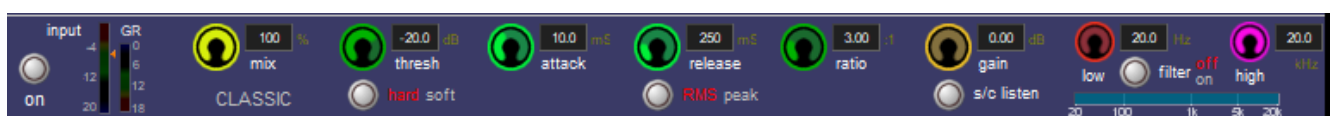

Vintage VCA

The Vintage VCA compressor models classic VCA compressors, with a fixed attack time and an auto-release time. The user can set the **threshold** and **ratio**.



Optical

The optical compressor models classic opto-compressors, with a unique release characteristic that models the gain reduction provided by an optical compressor circuit. It has three options for **attack** time and **recovery** time, along with a **ratio** control.

The gain reduction also behaves uniquely by having a ratio-dependent maximum gain reduction value, with the compressor continuing to be linear above this value.



FET Limiter

The FET limiter has a fixed threshold like many classic FET limiters, however the **input** and **output** gain knobs can be adjusted accordingly in order to achieve the desired output level and gain reduction. The **attack** and **release** values can be adjusted and the **ratio** can be set at either 4:1, 8:1, 12:1 or 20:1.

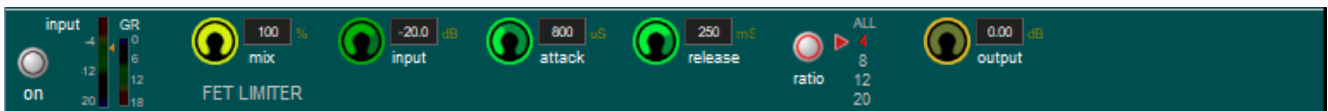

1.9.8 Gate/Ducker

The gate/ducker works functions similarly to the gate and ducker found in the standard SD channel strip, however it has different attack and release shape characteristics.

An external sidechain source can be selected, which can then be sent to the sidechain of the compressor and/or gate/ducker.

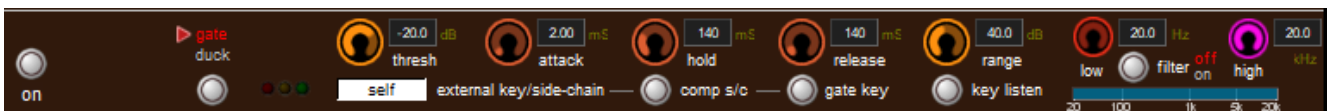

1.10 Spice Rack

Spice Rack is the new audio processing rack on Quantum engines. It was released with the Chilli 6 Multiband Compressor and also now includes a 6 band Dynamic EQ called Naga 6.

The Spice Rack can be accessed by touching the Master Screen > **Processors** then **Spice Rack**.

Soloing a channel with a Spice Rack processor inserted will bring up the Spice Rack and the relevant slot.

1.10.1 Chilli & Naga 6 Overview

The screenshot shows the Spice Rack interface for a channel named 'Kick'. The interface is divided into several sections:

- Top Bar:** Contains 'Ch 1 ins A', 'Kick', 'safe', 'touch assigns', 'faders', 'touch turn', 'presets', 'mono', 'stereo', 'Chilli 6', and 'type'.
- Left Panel:** A list of current units in the Spice Rack slots, numbered 1 to 6, all labeled 'Chilli 6 - Kick'. Below this is a 'Listen Destination' section with 'Solo 1', 'Solo 2', and 'Destructive' options.
- Main Area:**
 - Release Shape:** A graph showing the frequency response of the processed signal.
 - EQ Section:** Includes 'Crossover Low', 'Crossover Mid', and 'Crossover High' with various frequency and gain settings.
 - Compressor Section:** Includes 'Side Chain' (none), 'Source Route', 'Output', and 'Thresh' (threshold) settings.
 - Dynamic EQ Section:** Includes 'Dyn Angle', 'Gain', 'Range', 'Attack', and 'Rel' (release) settings.
 - Side Chain Section:** Includes 'All Int', 'All Ext', 'Int', 'Ext', 'All Split', 'All Wide', 'Split', and 'Wide' options.
 - Thresh Section:** Includes 'Thresh' settings for each band.
 - Bypass Section:** Includes 'Byp' (bypass) and 'Listen' buttons for each band.
- Right Panel:** A vertical scale for the side chain source and type, ranging from 18 to -50 dB.

Annotations with red lines point to specific features:

- 'List of current units in the Spice Rack slots. Inserted units display the channel name.' points to the left panel list.
- 'The channel and insert where the device is routed' points to 'Ch 1 ins A'.
- 'Safe the current Spice Rack processor' points to the 'safe' button.
- 'The user interaction type' points to 'faders'.
- 'Open the presets' points to the 'presets' button.
- 'Link two Chilli 6 units together' points to the 'type' button.
- 'Select the Spice Rack device type' points to 'Chilli 6'.
- 'The current frequency response of the processed' points to the Release Shape graph.
- 'The dB range that the compressor will act over' points to the Thresh section.
- 'These set the side chain source and type' points to the Side Chain section.
- 'This sets the solo' points to the 'Solo 1' button.

The Naga 6 can be accessed by selecting a Chilli 6 unit and pressing the type button, then choosing Naga 6.

Chilli 6 is a classic multiband compressor with four flat top filter type bands with shared crossover slope and two separate parametric bands. The Naga 6 is a Multiband Dynamic EQ with six parametric bands and no flat top filters. They both allow frequency specific dynamic control with compression or expansion applied to audio above a set threshold. When stereo channels are routed to the Spice Rack, two consecutive slots are automatically set to stereo, therefore ganged together. They can be set back to mono to allow the units to have different parameters. Before units can be stereo linked the pair of units have to be set to the same type Chilli 6 or Naga 6. Pairs have to be neighbouring units such as 1 and 2, 3 and 4, 5 and 6 etc. Note that 2 and 3, 4 and 5 etc cannot be made into a stereo pair.

The green line represents the frequency response of the processed audio and reflects the compression or expansion applied in real time.

The **Release Shape** is used to alter the release characteristic with curve type exponential (0) through linear (0.5) to inverse exponential (1). Inverse exponential is a new feature which reduces sharp decays between peaks in signal, whilst maintaining the same overall decay time.

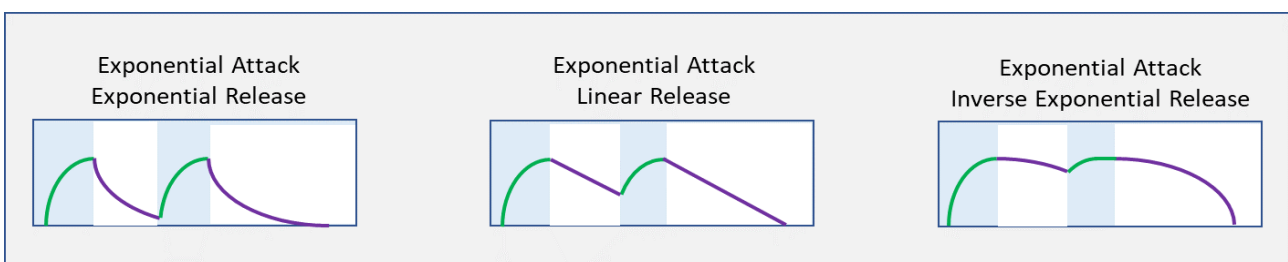

Dynamic Angle affects how far above the threshold the signal needs to be before the full range of EQ is applied, similar to a ratio with a smooth transition through the threshold. This can be set anywhere between 1 (default) equivalent to a higher ratio and 0, a lower ratio. Also similar to a knee, when the Dynamic Angle is set to a value less than 1, gain reduction will be applied to signal below the threshold however will always maintain a soft curve.

Parametric (Bell) Filters. The six bands on the Naga 6 and two of the bands (P1 and P2) on the Chilli 6, are parametric EQ type filters, which have a centre frequency range of 20Hz – 20kHz and Q of 0.35 – 60. When the band is set to “Split” mode, these bands also have their own independent flat top filter bands, which are used only on the side chain dynamic control and as isolating filters when soloing the band. The centre frequency of these bands follow the frequency control of their main parametric filter, and the width adjusts in sympathy with the main “Q” control. Setting the band to “Wide” bypasses the flat top filter in the dynamic side chain control such that the side chain is fed directly from the input signal, although these filters remain active as isolating filter when soloing.

Flat top filters. On the Chilli 6 only, bands **1 – 4** have three crossover filters which are used to position the bands over the desired spectrum. A global **Crossover Slope** adjusts the filter slope between second order (0) and true fourth order (1). When a band is set to split mode, the side chain control signal is fed post the filter and will respond only to audio within the band, but when set to “Wide” the side chain is fed directly from the input and will respond to the whole spectrum. Soloed signals will always pass through the filter regardless of the “Split”/“Wide” state.

Gain acts as a level adjustment for each band.

Range determines the limits of compression or expansion applied to a particular band. When activated, the dynamic range is shown by a blue highlight either above (expansion) or below (compression) the current gain in the graphical display.

External Side Chain. Pressing the “Side Chain Source Route” will allow you to select an external source to be used as a side chain. Each band can be set to use this one signal as it’s side chain source independently by pressing the “Int” / “Ext” buttons. Any band not using Ext reverts to using self (the input signal) as it’s source. “Ext” cannot be selected if no externally route has been set up.

Soloing Bands. Only one band can be soloed at a time, by pressing the “listen” button in the band. With listen Source set to “Band” the solo will monitor the input signal passing through the bands filter controlled by the dynamics, and in the case of parametric filter bands, the signal will also be passed through a side chain isolating flat top filter. This is so that when notch filters (Bell cut) are used, the effected audio region will be isolated. When Listen source is set to “S/C Listen” the external S/C signal (if set to external) or the input signal, will be passed through its own flat top side chain filter. This filter will not be controlled by the dynamics as it is monitoring the source that is controlling the dynamics.

Listen/Solo Destination. The soloed band can be sent to the “Solo 1”buss , the “Solo2” buss, or both, without altering the normal signal going through the spice rack (non-destructive). Alternatively, Pressing the “Destructive” button will make the soloed band replace the spice racks normal output with the soloed signal. These controls are global to all the units in the spice rack.

Attack and Release determine the speed at which the compression or expansion acts on the signal.

Threshold sets the point where compression or expansion is applied.

There is an overall **Output** fader which can be used to make-up or reduce a post-effect gain difference.

Any of the bands can be set to **Bypass** which sets the gain and range for that band to 0dB, maintaining the overall phase. **Bypass All** applies a blanket bypass across all bands which keeps the state of the individual bypasses.

1.10.2 User interaction options

1. Faders

Parameters can be touched on screen to determine which row of controls are assigned to the Quantum 2 faders. Mute buttons act as bypass and solos act as listen in this option.

2. Touch turn

Each parameter can be pressed individually to be controlled by the touch turn rotary. The touch turn button toggles the bypass state when on-screen rotaries for that band are selected and listen state when the on-screen faders are selected.

1.10.3 Presets



Presets allow the ability to recall and save parameters for a particular setup of a Spice Rack effect. **New** will create a preset with the current parameters in the effect, this will be stored under a group. **Default** will recall the default settings for the effect in the current slot.

When **edit name** is selected, the group name, preset name and notes can be altered. Factory presets are locked and cannot be altered or deleted.

A variety of factory presets are available as starting points for use on different audio sources.

The Naga 6 has the addition of six static gain curves (Band Gains), colour coded to the appropriate band, and as such there are three display option buttons which allow you to mix and match the graphic display. The live animated spectral gain indicator (the green line) remains visible at all times.

Band Gain Filters only

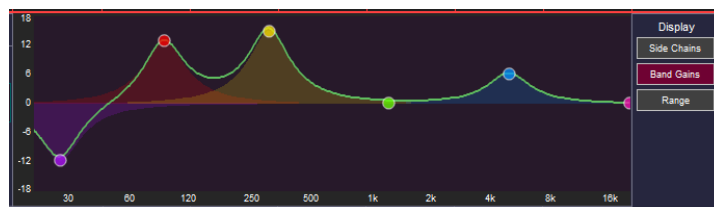

Side Chain/isolating Filters only

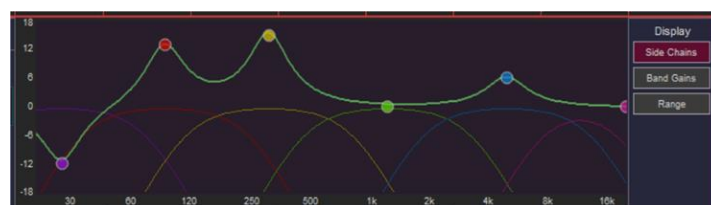

Range only

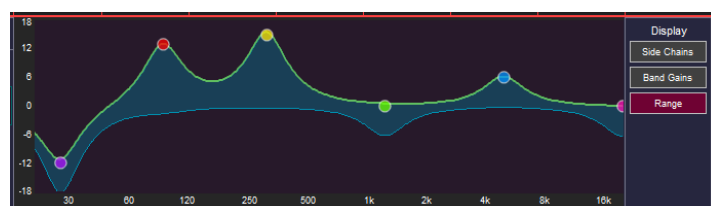

1.11 Auxiliaries

The auxiliaries can be accessed by pressing the **Quick Select Aux button** and touching the auxiliary row on screen or using the **Screen Scroll** buttons on the left of the worksurface

Using either of these methods, the highlighted auxiliaries on the input screen will change. The rotary controls and switches beneath the screen are used as auxiliary sends, pans (with 2nd Function ON), On/Off and pre/post switches (with 2nd Function ON).

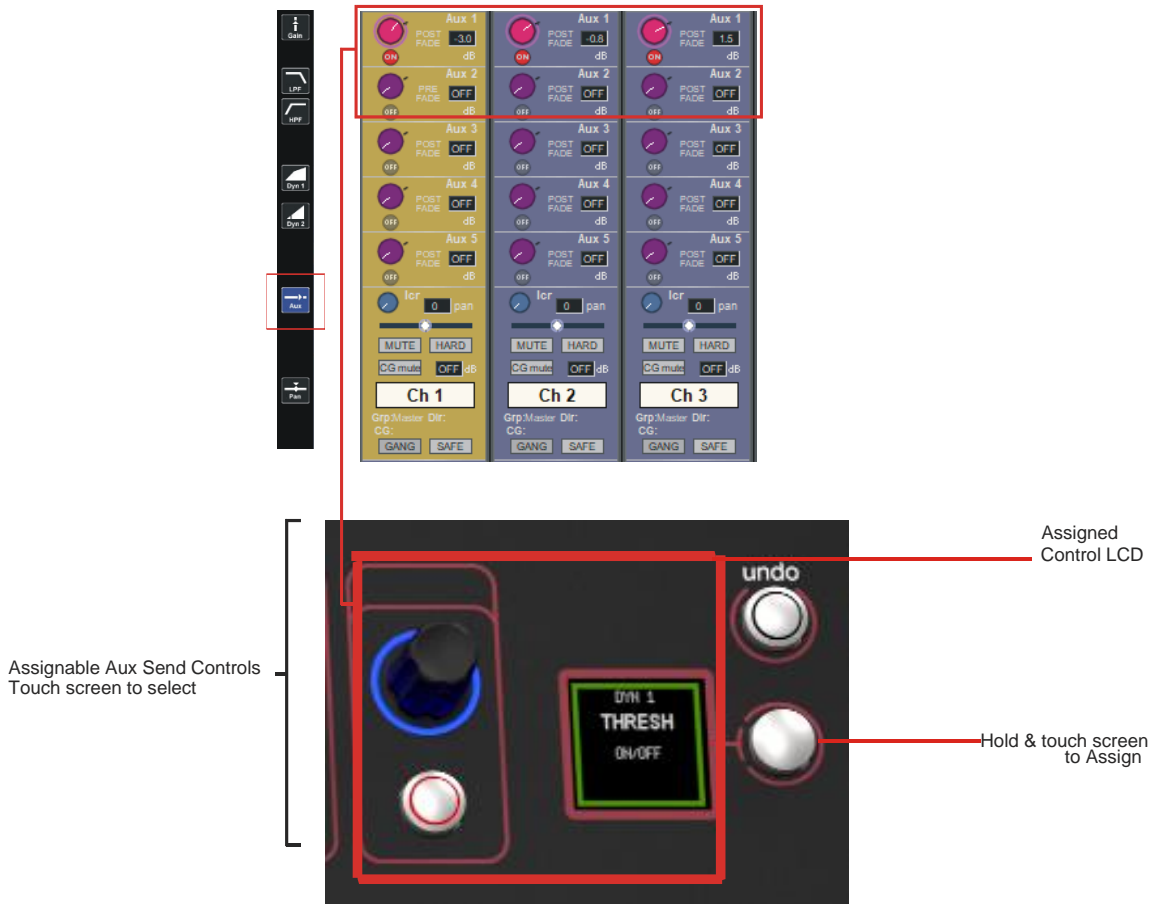

It is also possible to show all of the aux sends for a channel in a single display and assign them to the 12 rotaries beneath the screen. This is done by touching the currently assigned aux row on the screen for the channel that you want to display. The layout of the display indicates which encoder each aux is assigned to; if there are more than 24 sends, the assignments becomes scrollable using the **Screen Scroll** function.

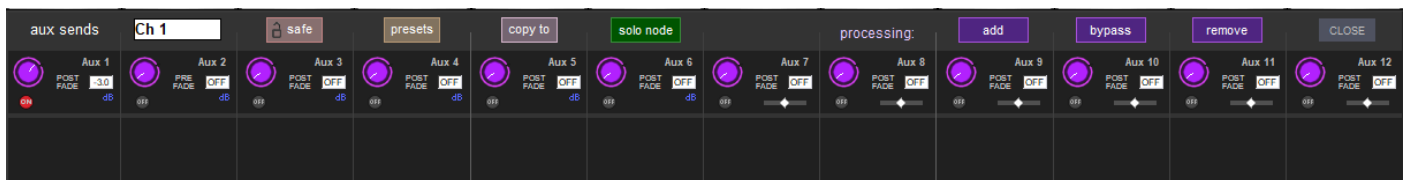

Once you have adjusted the auxes in this display, you need to close it manually before opening any other channel detail display.

1.12 The Matrix

To open the Matrix Inputs panel, touch the **Matrix** button on the Master Screen. The window that opens allow you to route inputs to the Matrix Output Channels and set the Matrix crosspoint levels.

To route an input, touch the top of the appropriate Matrix column. This opens a standard QUANTUM 2 input routing page.

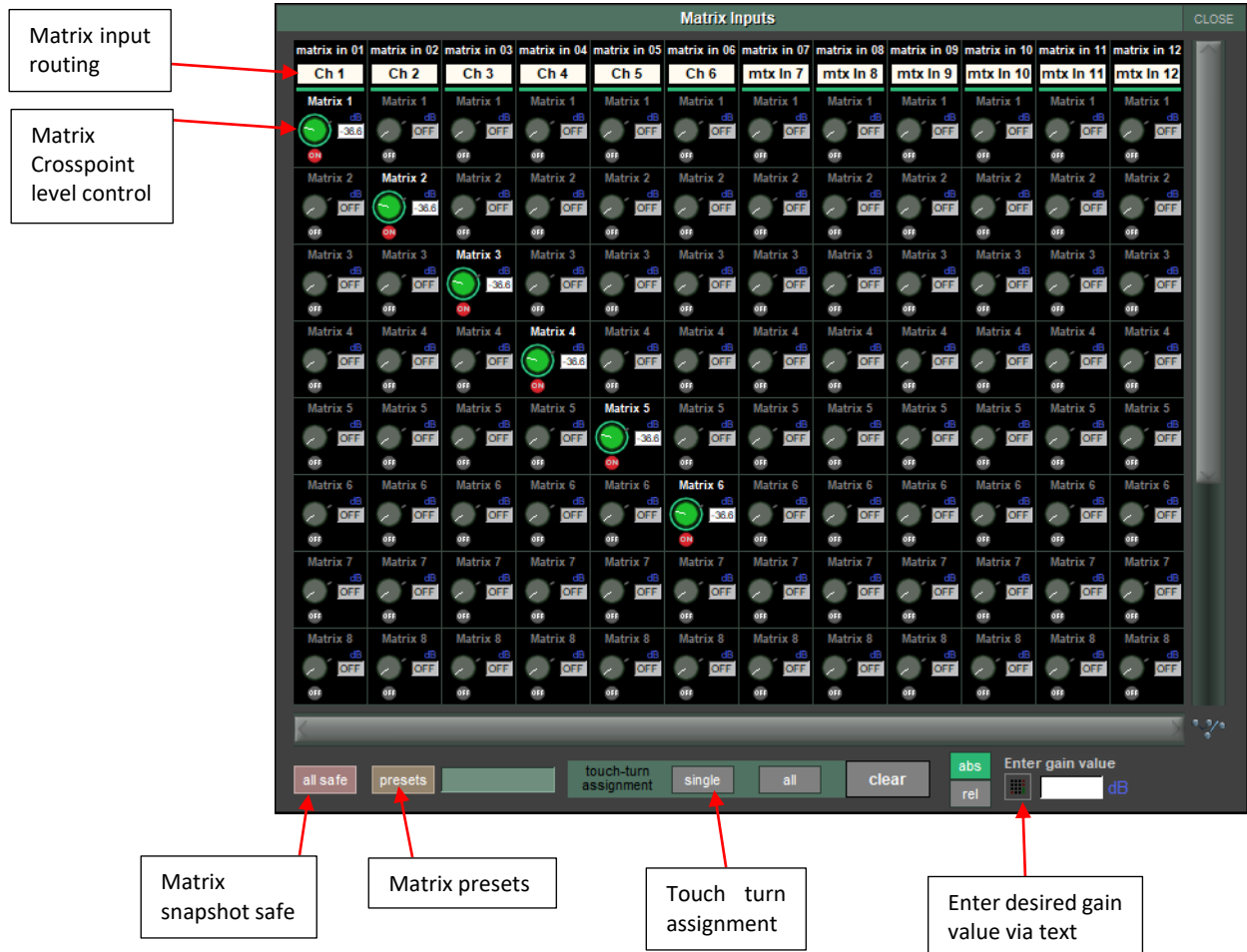

There are five modes of level adjustment: multi, single, all, absolute text and relative text.

Multi (active when no other mode is selected): Touch one or more level “knob” on screen, then adjust using the Touch Turn control.

Single : Touch any level “knob” and adjust. Touching another “knob” will deselect the first.

All : All “knobs” are adjusted at the same time.

When adjusting more than one crosspoint, their relative levels are maintained.

Abs Text: enter the numerical value in the box using a keyboard or the on-screen numpad, all selected “knobs” will have their gain set to that value.

Rel Text: the value entered in the text box changes all selected “knobs” by the entered amount.

The **clear** button cancels all active Touch Turn assignments.

1.13 Control Groups

Any number of input channels and output channels can be connected to one or more of the 12 possible Control Groups. They can then all be operated from a single worksurface control. Changes to the Control Group fader, mute or solo or controls will affect all channels connected to the group.

There are 2 methods to set up Control Groups:

- 1) Press the **LCD Function** button on the CG fader bank followed by the **JOIN CG** button; Press the channel select button for the CG that you want to use; Press the channel select buttons for each of the channels to be included in the CG; Deselect the **JOIN CG** button:

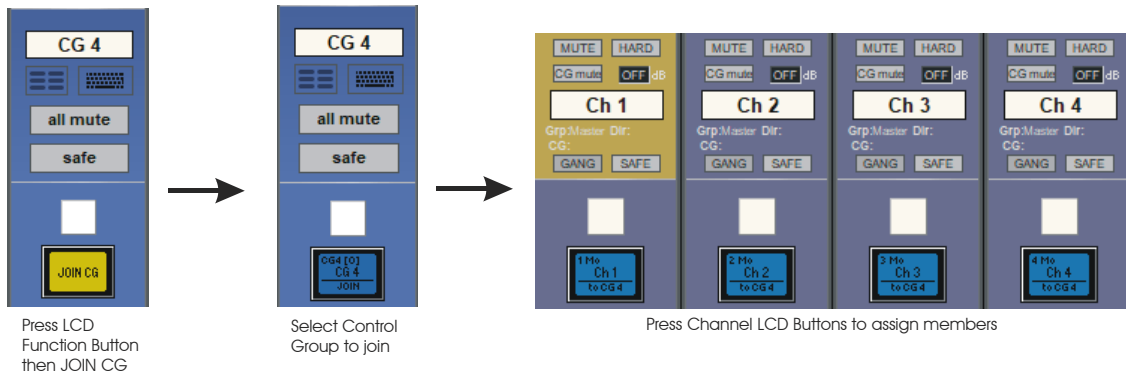

- 2) Press the on screen **JOIN/LEAVE** button for the required CG channel; Press the channel select buttons for each of the channels that you want to make members of the CG; Release the **JOIN/LEAVE** button:

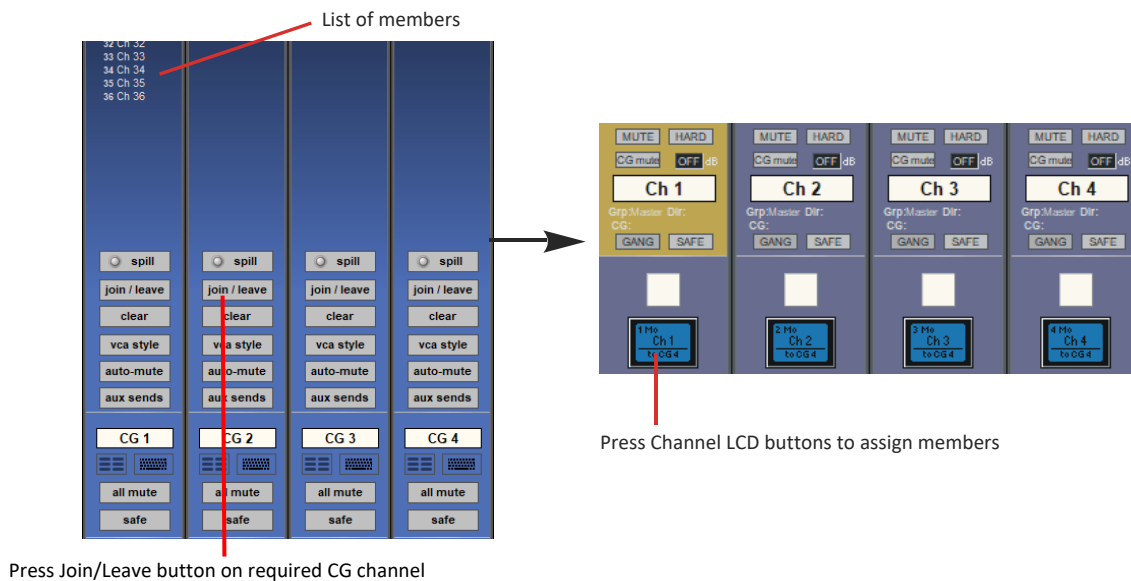

A list of all the connected channels and their names is displayed above each Control Group display.

You can also clear all the channels from a Control Group by pressing **Clear**.

When a channel is a member of a Control Group, its own controls can still be adjusted independently of the other CG members. Adjustments to fader levels are transmitted to the CG members as dB changes, so that a level increase of 2dB on the CG fader will increase all the member levels by 2dB, irrespective of the relative levels of the individual channel faders.

CG Mutes are treated as “in series” where a channel is a member of more than one group. All CG mutes must be off for a channel to be unmuted; any CG muted always mutes all of its members.

If a channel is CG muted by single or multiple CGs, the worksurface channel mute button will override all CG mutes for that channel. The channel will not however be removed from CG membership so if the relevant CG is muted again, the channel will also be muted.

1.14 Multi-channel formats

Multi-channel inputs are controlled by routing each component through a mono channel and then linking those channels via a 'Multi' channel. To start with, use the normal input and output routing procedures to route each component through a channel. Then open the Setup display for the first component, and select **Multi** at the top, to open the **Setup Multi Channels** display. Select the format – **LCR**, **LCRS**, **5.1** or **multi-input** (which allows you up to 11 components) – and then press the LCD buttons for the remaining component channels, working down the displayed list in order. Channel names will appear against each component. Each channel can then be left on the worksurface or removed using the buttons towards the base of the display. Finally, touch **OK** to close the display to link the channels together.

Note that you can also create Multis on a blank layer by selecting the Create Multi LCD function on the Layer you wish to use, then pressing the LCD button for the required channel strip.

The included channels are shown in the Multi-channel strip. Touching the **Folded Controls** button allows you to control which channel elements are displayed in the folded channel strip – each element affects all linked components.

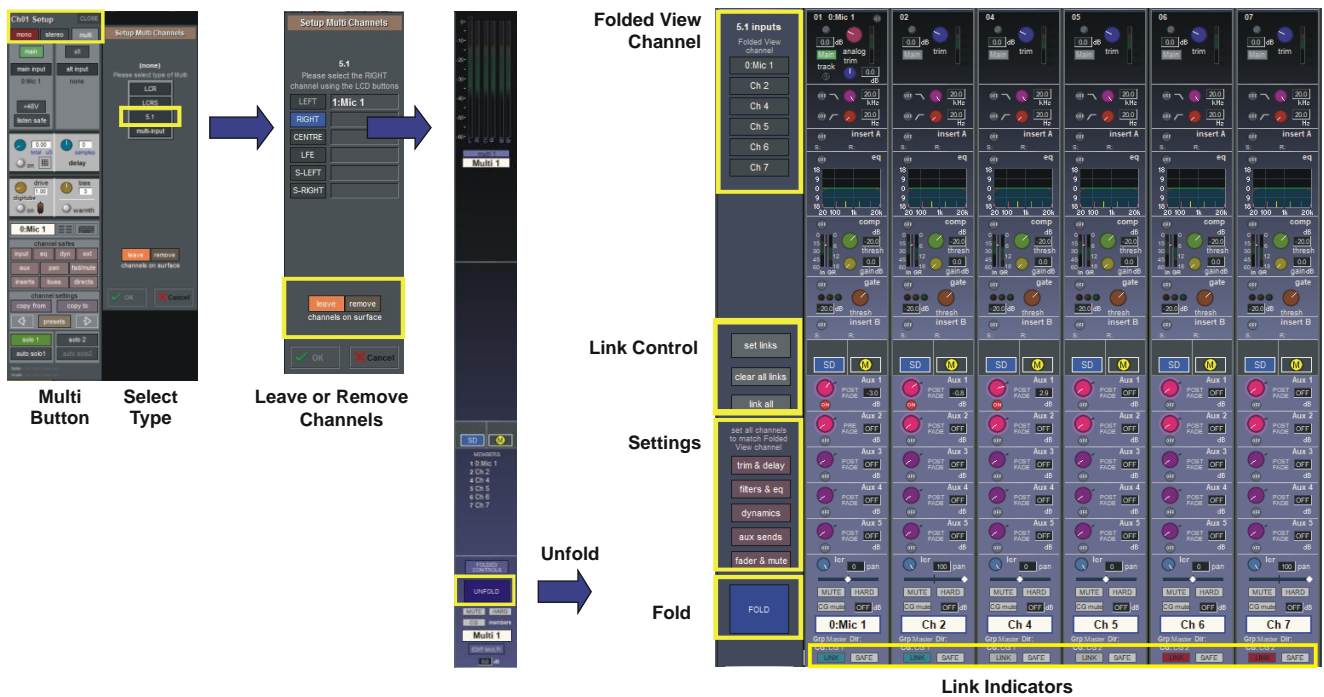

If the **Unfold** button in the Multi or in a multi-channel buss channel strip is pressed, the component channels will be displayed, and more detailed configuration can be made.

See the SD/Quantum Series Software Reference Manual for more information on Multi Channel formats

1.15 Solo Setup

The QUANTUM 2 Solo panel is accessed from a button at the top of the Master Screen. Some of the controls on this panel are duplicated on the worksurface master section



There are two solo busses and each solo button on the console can be independently assigned to use Solo1, Solo2 or Solo 1+2. Therefore, if the console was being used for Stage monitors, the first solo buss could feed “In-Ear” monitors, and the second solo buss could feed a wedge.

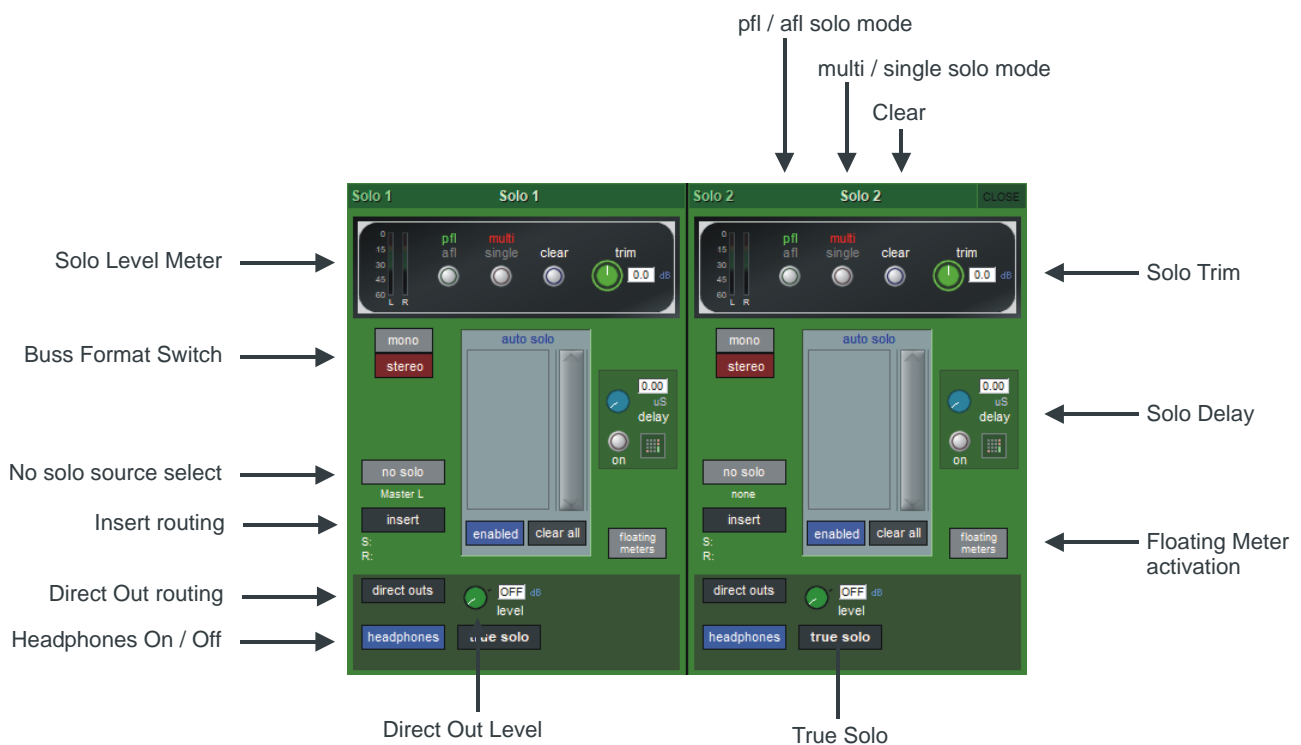

The following functions are available independently for each solo buss :

- **Mono / Stereo** Switch
- **No Solo** source routing: The source for solo buss when no channel is in solo mode.
Note that the No Solo source does not show on Solo meters
- **Insert** Point with both internal and external routing capability
- **Direct Out** routing (eg. for feeding a wedge)
- Assignment of Direct Out level control to master fader or speaker volume pot
- **afl** or **pfl** mode
- **single** or **multi** solo mode
- **Delay**
- **Level Trim**
- **Auto solo** mode: If a channel is set to **Auto Solo**, it will automatically solo when another channel is soloed. The **Auto Solo** function of each solo buss can be enabled and disabled as required.
- **Solo meters** can be displayed on the Master or Overview screen by pressing the **floating meters** button below the solo **delay** area in either side of the **Solo** panel.

DMI Cards

The DiGiCo QUANTUM 2 has two option slots on its rear panel for the installation of DMI cards (see below). These cards come in a variety of I/O types.

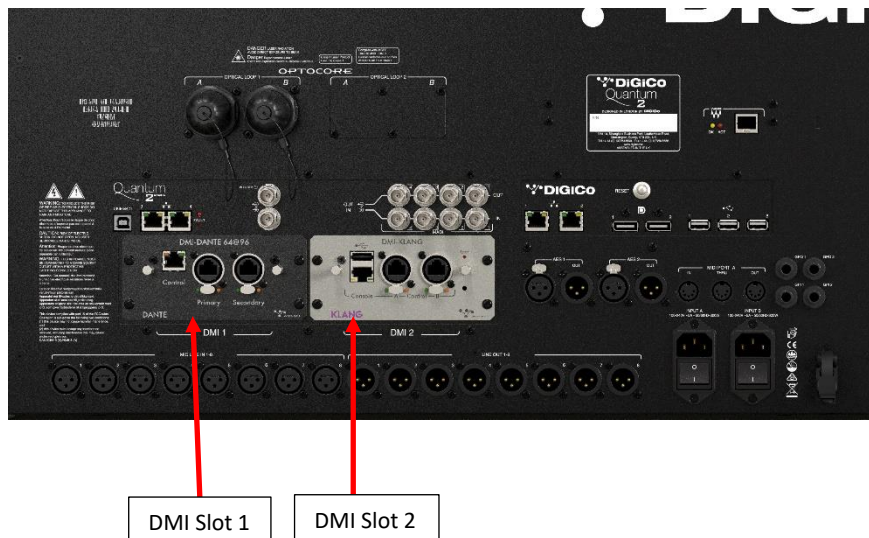

2.1 Fitting DMI Cards

NOTE: DMI cards are NOT hot swappable and therefore they should NEVER be fitted or removed from the console while the console is powered on.

To fit a DMI card:

- 1) Remove the four screws from the console blanking plate and this will expose a hole in the rear panel with an internal connector and a white slider on each side of the hole. Keep the four screws safe in order to secure the card in place.

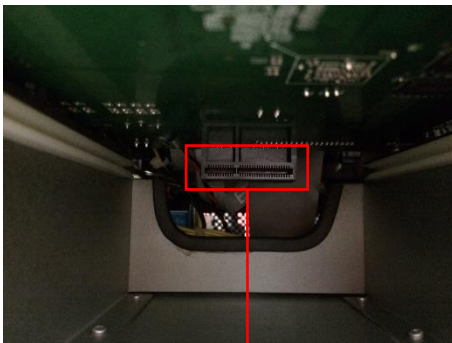

DMI Internal Socket

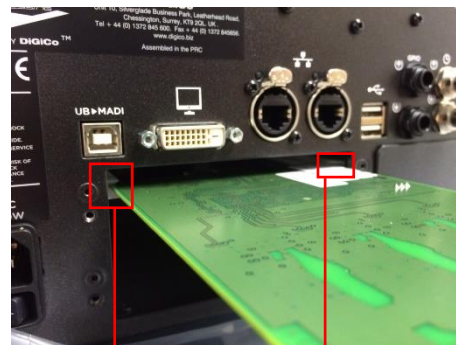

Card fits in slider grooves

NOTE: Before fitting the DMI card, carefully examine the internal connector as in some cases this may have a protective cover that must be removed before fitting the card. If the cover is present, please remove it before proceeding

NOTE: With the DMI-MADI C there are 2 internal switches that must be set to the A position for use in the console. Please check these switch positions (as picture below) before fitting the card.

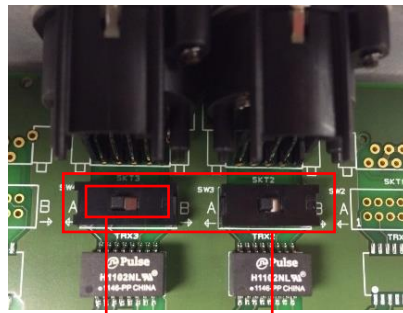

Position A for DMI-MADI C internal

- 2) Carefully slide the DMI card in the hole using the while slider grooves as a guide and then ensure that it pushes into the internal connector correctly with a click.
- 3) Replace the 4 fitting screws.

2.2 DMI-MADI Cards

There are 2 types of DMI-MADI Card:

MADI B has 2 pairs of BNC connectors

MADI C has 2 bi-directional Cat5e connectors

Both of these cards can be used to connect a Standard MADI stream at 48KHz or 96KHz or an SD-Series DiGiCo Rack with the appropriate connector (D-Rack, D2-Rack, SD-Rack, SD-MiNiRack).

NOTE: Only one DiGiCo Rack can be connected to a single DMI-MADI card at one time.

NOTE: With QUANTUM 2 software V14.0.1400+, cable redundancy at 48KHz using both the Main and Aux MADI ports on a D2-Rack, SD-Rack or SD-MINIRack is not implemented

2.2.1 Connecting DMI-MADI

External audio connections can be made using either BNC MADI (AES10) or the DiGiCo Cat5e Connection.

There are 2 types of MADI connection available. A DiGiCo Stage rack can be connected to a console via a bi-directional MADI connection will have up to 112 channels (56 in, 56 out) of audio plus the control data for the Rack (located on CH57). A bi-directional standard MADI stream will contain up to 128 channels of Audio (64 in, 64 out) and can be connected to any 3rd party device that has MADI connectivity.

A DiGiCo Cat5e connection is a bi-directional up to 64 Channel interface that uses STP Cat5e Cable with interference suppressors fitted on each end used to connect D-Racks and D2-Racks.

Please carefully note the following connection requirements:

DMI-MADI C to D-Rack at 48KHz

Connect DMI card Cat5e socket A to D-Rack Cat5e socket.

DMI-MADI C to D-Rack at 96KHz

Connect DMI card Cat5e socket A to D-Rack Cat5e socket.

NOTE: This setup provides one 28 channel 96kHz MADI stream therefore D-Rack input sockets 29-32 will not pass audio.

Single Console to D-Rack with DMI MADI C Card

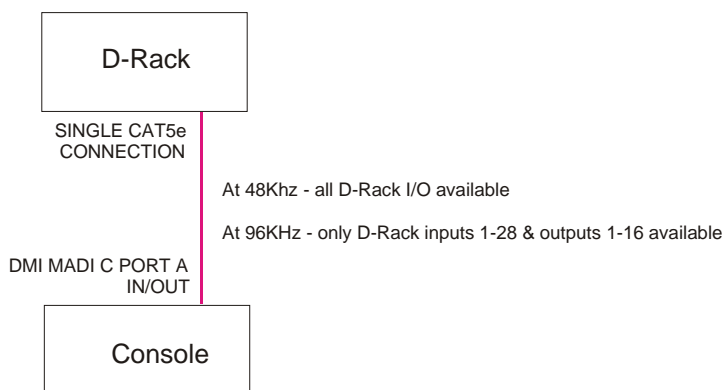

Audio Sync = MASTER

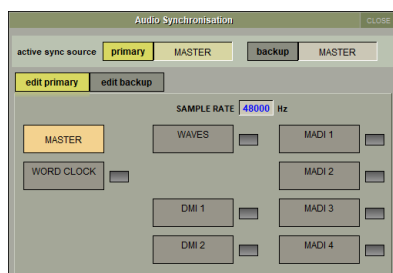

DMI-MADI C to D2-Rack at 48kHz

Connect DMI card Cat5e socket A to D2-Rack Cat5e Main socket.

Single Console to D-Rack with DMI MADI C Card

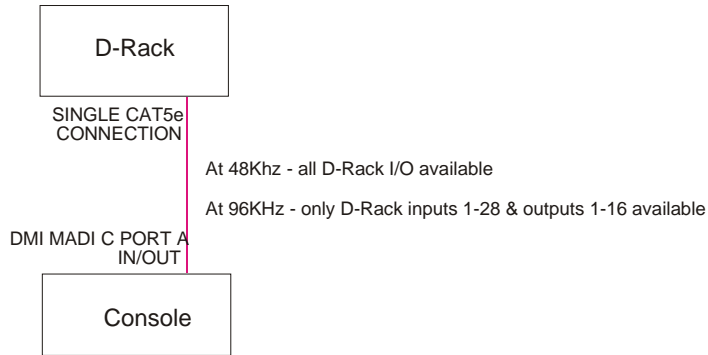

Audio Sync = MASTER

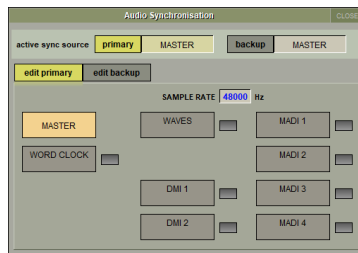

DMI-MADI C to D2-Rack at 96kHz

Connect DMI card Cat5e socket A to D2-Rack Cat5e MAIN socket.

Connect DMI card Cat5e socket B to D2-Rack Cat5e AUX socket.

Single Console to D2-Rack with DMI MADI C Card at 96KHz

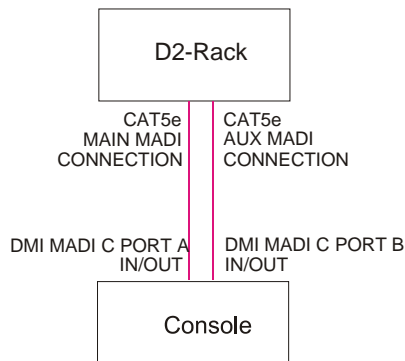

Audio Sync = MASTER

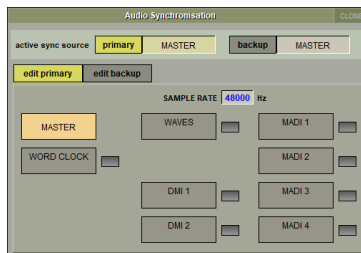

DMI-MADI B to D2-Rack, SD-Rack or SD-MiNiRack at 48kHz

Connect DMI card BNC IN socket A to D2-Rack BNC OUT MAIN socket.
 Connect DMI card BNC OUT socket A to D2-Rack BNC IN MAIN socket.

Single Console to D2-Rack with DMI MADI B Card at 48KHz

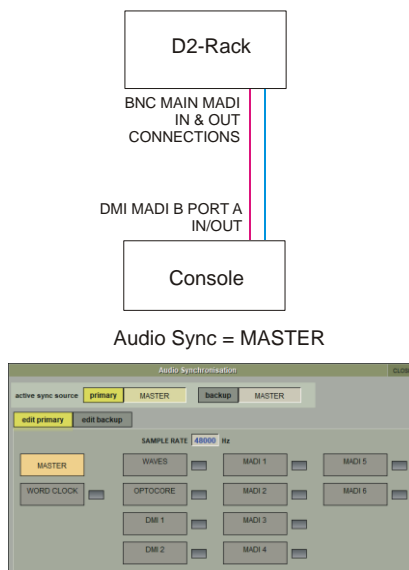

DMI-MADI B to D2-Rack, SD-Rack or SD-MiNiRack at 96kHz

Connect DMI card BNC IN socket A to D2-Rack BNC OUT MAIN socket.
 Connect DMI card BNC OUT socket A to D2-Rack BNC IN MAIN socket.
 Connect DMI card BNC IN socket B to D2-Rack BNC OUT AUX socket.
 Connect DMI card BNC OUT socket B to D2-Rack BNC IN AUX socket.

Single Console to D2-Rack with DMI MADI B Card at 96KHz

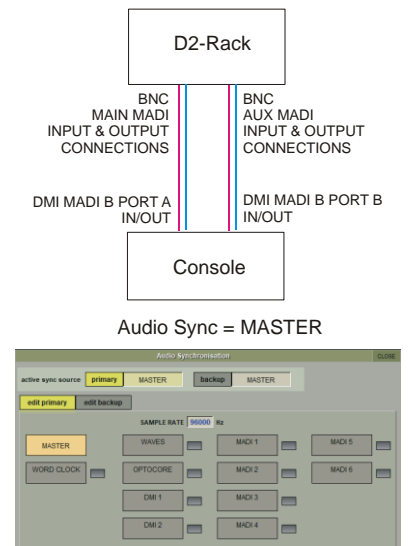

DMI-MADI B to a Standard MADI device at 48kHz

Connect DMI card BNC IN socket A to Standard MADI device BNC OUT.
 Connect DMI card BNC OUT socket A to Standard MADI device BNC IN.

DMI-MADI B to a Standard MADI device at 96kHz

Connect DMI card BNC IN socket A to Standard MADI device CH 1-32 BNC OUT.
 Connect DMI card BNC OUT socket A to Standard MADI device CH 1-32 BNC IN.
 Connect DMI card BNC IN socket B to Standard MADI device CH 33-64 BNC OUT.
 Connect DMI card BNC OUT socket B to Standard MADI device CH 33-64 BNC IN.

2.2.2 Sharing Racks with DMI-MADI

If the system is running at a sample rate of 48KHz a D2-Rack, SD-Rack or SD-MINIRack can be shared between 2 consoles (Two QUANTUM 2s or an QUANTUM 2 and another S or SD-Series console) with the connection system shown below.

In this setup:

- 1) All inputs can be shared by the two consoles but only one console controls the rack analogue gains (the "Master" console)
- 2) The console which is not controlling the gains (the "Slave" console) can automatically adjust its digital trims to compensate for the gain changes using a system known as "Gain Tracking" (see below)
- 3) Only the "Master" console can use the outputs of the shared rack

The recommended connection between the Monitor (Slave) console and Stage Rack is a single MADI OUT from the Shared Rack's AUX MADI connected to the console's MADI A IN

The FOH (Master console) is connected via MADI A IN and OUT to the stage rack.

A similar method can be used if the Monitor console requires gain control and the FOH console will track the gain changes.

MADI OUT from the Shared Rack's AUX MADI connected to the FOH console's MADI A IN.

The Monitor (Master console) is connected via MADI A IN and OUT to the stage rack.

*Note: The "Master" console should be set to provide "Master Sync" (Setup>Audio Sync menu - see diagram below) to the Shared rack
The "Slave" console should be set to receive its Audio Sync from the MADI DMI slot that is connected to the Shared Rack.*

- 1) The operators should agree on and set a level of analogue gain that provides enough headroom for the required application.
- 2) The second console should connect to the Shared rack in **Receive Only** mode (only MADI Input cable connected)
- 3) **Gain Tracking** (the **GT ON/OFF** button at the top of the Input channel setup view) can be switched on for the console that is in **"Receive Only"** mode for all the channels that are being shared.
- 4) When an analogue gain control is changed on the "Master" console, the "Slave" console's analogue gain should reflect the changes and the digital trim control should compensate for this change by moving by the same amount in the opposite direction.

*IMPORTANT Note: If Gain Tracking is active on a channel, the digital trim control will still respond to the local gain adjustment by compensating locally for the displayed gain change.
If the "Slave" console loads a session where the Analogue Gain and +48V settings do not match the current state of the racks, the Master console should then reload its session to update the state of these controls on the "Slave" console*

FOH & MONITORS WITH SHARED RACK at 48KHz USING MADI

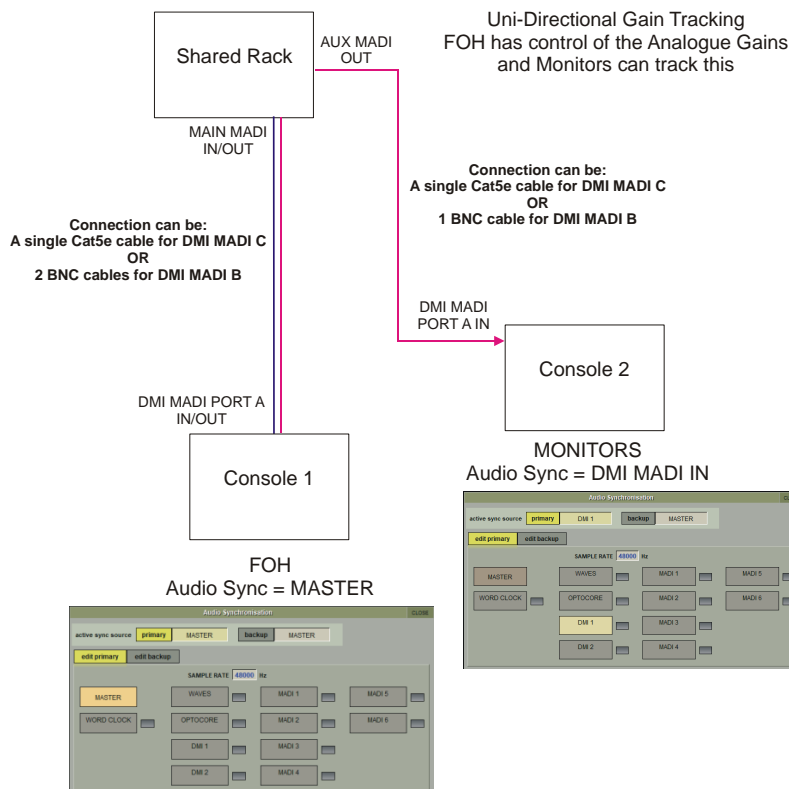

If the system is running at a sample rate of 48KHz, a D-Rack can also be shared between 2 consoles (Two QUANTUM 2s or a QUANTUM 2 and another SD-Series console with Cat5e connections eg SD9 or SD11) with the connection system shown below.

This setup is similar to the one previously described but requires a DiGiCo Little Red Box.
 The Little Red Box has separate Cat5e connections for:
 The D-Rack itself
 The FULL CONNECT " Master" console
 The RECEIVE ONLY "Slave" console

In all other respects the setup is the same as that for the D2-Rack and SD-Rack

SHARING A D-RACK at 48KHz USING MADI

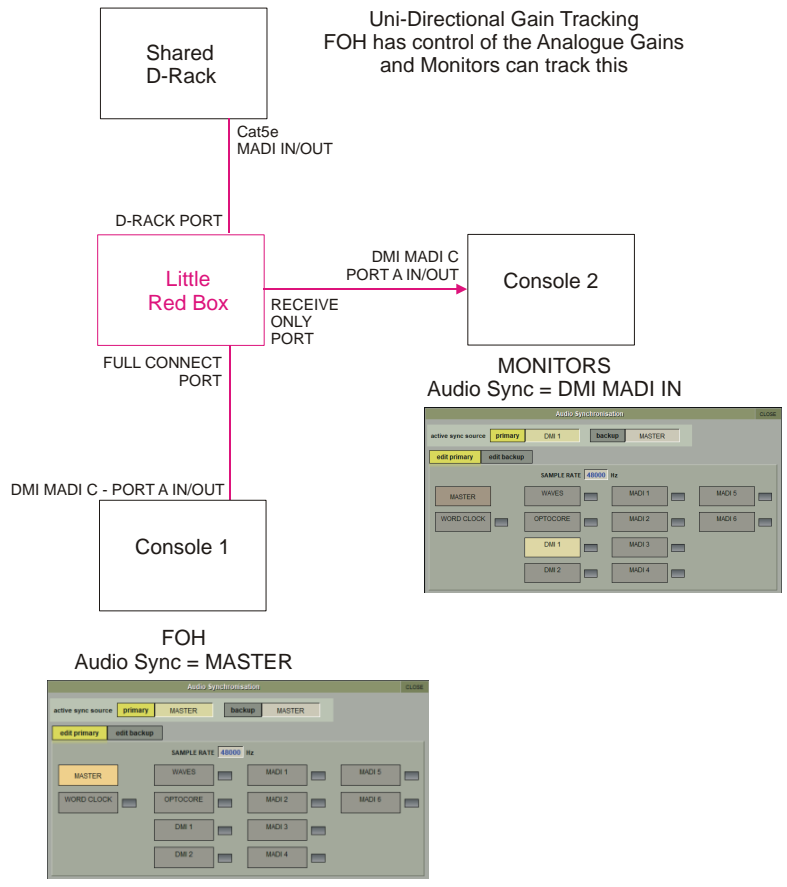

2.3 DMI - Dante Cards

A **DMI-Dante** card in a QUANTUM 2 console provides 64 input and 64 output channels at 48kHz and 32 input and 32 output channels at 96kHz. It is provided with Primary and Secondary (backup) Gigabit Ethernet ports for connection to the Dante network.



A **DMI-Dante 64@96** DMI card provides 64 input and 64 output channels at 48kHz or 96kHz, along with support for SRC (Sample Rate Conversion). This enables the desk to run at a different sample rate to the Dante network.



Sample rate conversion can be enabled in the Audio IO panel by enabling 'Auto SRC'. This will automatically switch on when necessary to convert the sample rate of the desk inputs and outputs to match the Dante network's sample rate e.g. the Dante network at 96kHz and console structured at 48kHz. SRC will not affect the number of input and output channels that can be routed.

For both Dante cards, all control and configuration of the Dante interface is done externally by the Dante controller software. A separate control computer must be provided to do this.

In S-Series, the Dante network can be set to use the console as the network system clock (in the Dante Controller software) or the Dante card can be selected as the console clock source.

In the picture below, the Dante Controller software displays two DiGiCo DMI Dante devices.

The second device in the list is installed in an QUANTUM 2 and has been manually labelled "DiGiCo QUANTUM 2".

In the Dante Device Config tab the QUANTUM 2 DMI-Dante card must be set to match the QUANTUM 3 sample rate at 48KHz or 96KHz

Example 1 - Console is Master clock for Dante Network

In the Dante Clock Status tab, the QUANTUM 2 DMI-Dante card is set to Sync To External and Preferred Master.

This setup enables the DMI-Dante in the QUANTUM 2 to take its Audio Sync Source from the console itself and in turn provide sync to the rest of the Dante network. The console would typically be set as Audio Master in the Main Menu > Audio Sync panel

The image contains three screenshots from the Dante Controller software:

- Left Screenshot:** 'Dante Controller - Device View (DiGiCoS21)'. The 'Sample Rate' dropdown is set to '48K'. A red box highlights this dropdown, with a red arrow pointing to the text 'Sample Rate'.
- Middle Screenshot:** 'Dante Controller - Network View'. The 'Clock Status' tab is active. A table shows the following data:

Device Name	Sync	Mute	Clock Source	Primary Status	Secondary Status	AE567 Status	Preferred Master	Enable Sync To External
DiGiCoDM			Dante	Slave	N/A	N/A	<input type="checkbox"/>	<input type="checkbox"/>
DiGiCoS21			External Clock	Master	N/A	N/A	<input checked="" type="checkbox"/>	<input checked="" type="checkbox"/>

 Red boxes highlight the 'Preferred Master' and 'Enable Sync To External' checkboxes for DiGiCoS21. Red arrows point from these boxes to the text 'Set Preferred Master & Sync To External'.
- Bottom Right Screenshot:** 'Audio Synchronization' panel. The 'active sync source' is set to 'primary'. The 'primary' button is highlighted with a red box, and a red arrow points from this box to the text 'Console Master Audio Sync'.

Example 2 - Dante Network is Master clock for console

If the console is required to use the Dante network as its sync source the following settings should be applied.
Enable Sync to External = OFF

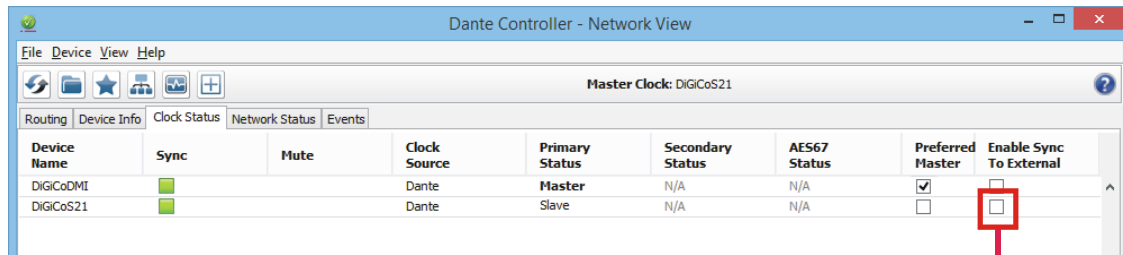

Sync To External = OFF

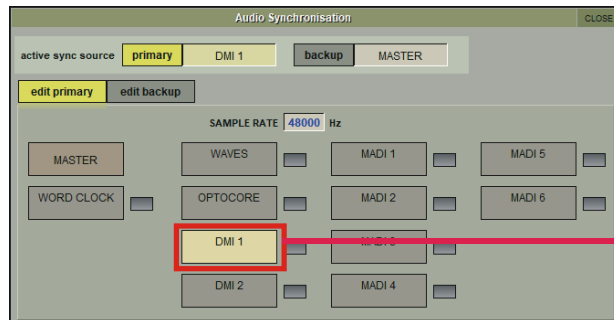

Console External DMI Sync

2.4 DMI - ADC - DAC - MIC - AES Cards



The **DMI-ADC** card provides 16 analogue inputs on 2 x 25 way "D" connectors. The ADC card is a line card only. There is no microphone amplifier or phantom power available. The S-series consoles have no gain control function for these inputs (only digital trim). Maximum input level +22dBu.

The **DMI-DAC** card provides 16 analogue outputs on 2 x 25 way "D" connectors. DAC card is line level only. Maximum output level +22dBu (Digital Full Scale).

The **DMI-MIC** card provides 8 microphone pre-amps on 1 x 25 way "D" connector. The S-Series consoles have control over phantom power, gain and pad on the card.

The **DMI-AES** card provides 16 Inputs (8 pairs) and 16 outputs (8 pairs) on 2 x 25 way "D" connectors. All AES inputs are provided with sample rate conversion (SRC) by default. All AES outputs are synchronised to the mixer system clock.

Multi-Pin Connector Pinouts

The DMI module range use 25 way "D" connectors, Female on the module (Male required on the connecting cable). The pins connections are as follows.

Analogue inputs and outputs			
Sorted by pin		Sorted by function	
Function	Pin	Function	Pin
8+	1	0	2
0	2	0	5
7-	3	0	8
6+	4	0	11
0	5	0	16
5-	6	0	19
4+	7	0	22
0	8	0	25
3-	9	1-	12
2+	10	1+	24
0	11	2-	23
1-	12	2+	10
nc	13	3-	9
8-	14	3+	21
7+	15	4-	20
0	16	4+	7
6-	17	5-	6
5+	18	5+	18
0	19	6-	17
4-	20	6+	4
3+	21	7-	3
0	22	7+	15
2-	23	8-	14
1+	24	8+	1
0	25	nc	13

AES-EBU combined in/out			
Sorted by pin		Sorted by function	
Function	Pin	Function	Pin
4out+	1	0	2
0	2	0	5
3out-	3	0	8
2out+	4	0	11
0	5	0	16
1out-	6	0	19
4in+	7	0	22
0	8	0	25
3in-	9	1in-	12
2in+	10	1in+	24
0	11	1out-	6
1in-	12	1out+	18
nc	13	2in-	23
4out-	14	2in+	10
3out+	15	2out-	17
0	16	2out+	4
2out-	17	3in-	9
1out+	18	3in+	21
0	19	3out-	3
4in-	20	3out+	15
3in+	21	4in-	20
0	22	4in+	7
2in-	23	4out-	14
1in+	24	4out+	1
0	25	nc	13

Pinout and connection notes:

0 = earth/ground or screen/shield nc = not connected + = phase/hot - = antiphase/cold

Analogue connections for input and output are connected in the same way, as shown. Analogue connections for channels 1-8 shown, channels 9-16 follow the same pattern (1 = 9, 2 = 10 etc.).

AES connections are shown as 4 stereo (2 channel) connections, equivalent to channels 1-8. AES connections for stereo connections 1-4 (ch 1-8) shown, connections stereo 5-8 (ch 9-16) follow the same pattern (1 = 5, 2 = 6 etc.).

2.5 DMI - Waves - Hydra Cards



DMI-Waves has 64 Inputs and 64 Outputs at both 48kHz and 96kHz - there is no control from the console, just simple routing of audio inputs and outputs.

Configuration of this card on the Waves network is done with Waves own software and Control Panels - please refer to Waves own documentation for SoundGrid Studio, Waves MultiRack or Waves SuperRack.

DMI-Hydra has 56 inputs and 56 Outputs and only functions when the console is at a sample rate of **48kHz** - there is no control from the console, just simple routing of audio inputs and outputs.

The ID of the card on the Hydra network can be changed from the console by touching the **Set Network ID** button, entering a new number using the on screen keyboard and the power cycling the console.

Configuration of this card on the Hydra network is done with Calrec's own software and Control Panels - please refer to Calrec's own documentation for details.

***IMPORTANT NOTE:** If a DMI Hydra card is used in the QUANTUM console, the console **MUST** be set to Clock Master. The Hydra DMI cannot be used as a clock source for the console itself.*

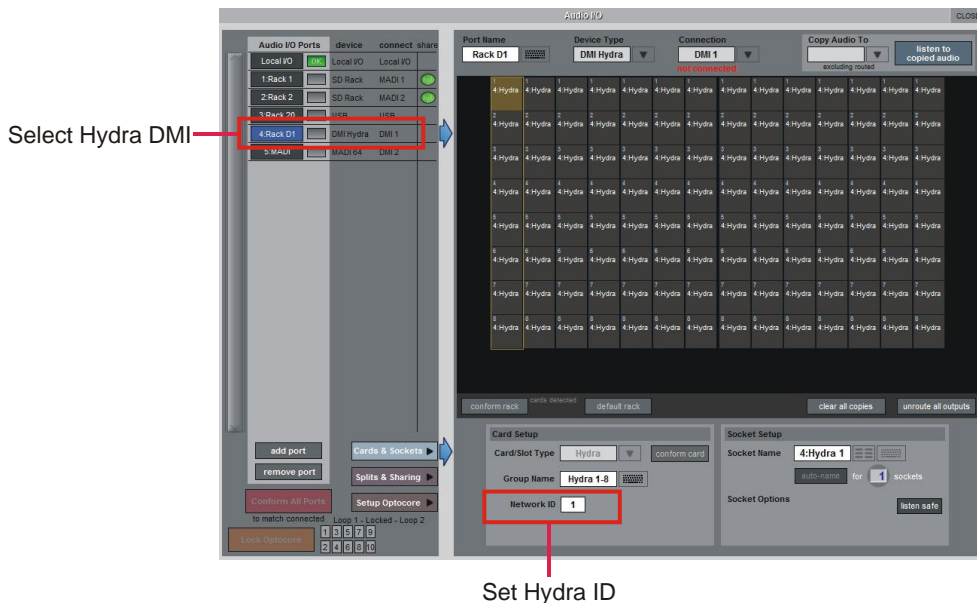

2.6 DMI - ME - A3232 Cards



The **DMI-ME** provides 40 outputs at 48kHz and 96kHz to Allen & Heath ME-1 or ME-500 Personal Mixers. There are no controls on the card.

The **DMI-A3232 (NOT COMPATIBLE WITH Q2)** allows connection to A168 STAGE Racks. Each Cat5 port supports up to 32 I/O, for a total channel count of 64 I/O. The rack can be run in two different modes. In Cascade Mode, up to two A168 racks can be connected to each port. In redundant mode, one A168 rack can be connected with redundant cabling to both ports on the card. When a DMI-A3232 is connected, each rack connected will be shown in a different view. The mode is changed by touching the desired mode in the **Port Control Mode** section.

QUANTUM consoles have control over gain, phantom power and pads of the rack.

NOTE: When changing the Port Control Mode, there is a physical switch on the A168 STAGE racks that must also be changed.

NOTE: The primary and secondary ports on the racks are not interchangeable. The primary port must be used as the main connection.

2.7 DMI – AMM

Quantum 338, Quantum 225, Quantum 7 and SD12 are compatible with the DMI-AMM card. The DMI-AMM card automatically manages live microphones in unpredictable dialogue situations. When one person speaks, that microphone’s gain level fades up instantly, while the other microphone gains are reduced. When the speaker pauses, all microphone levels will adjust to medium gain to collectively match the level of one microphone at full gain. The resulting effect will be as if all speakers are sharing one microphone. When several people talk at once, the gain is shared. The AMM Controls (**Figure 1**) can be found in the Audio I/O window after conforming the DMI card (**Figure 2 & 3**).

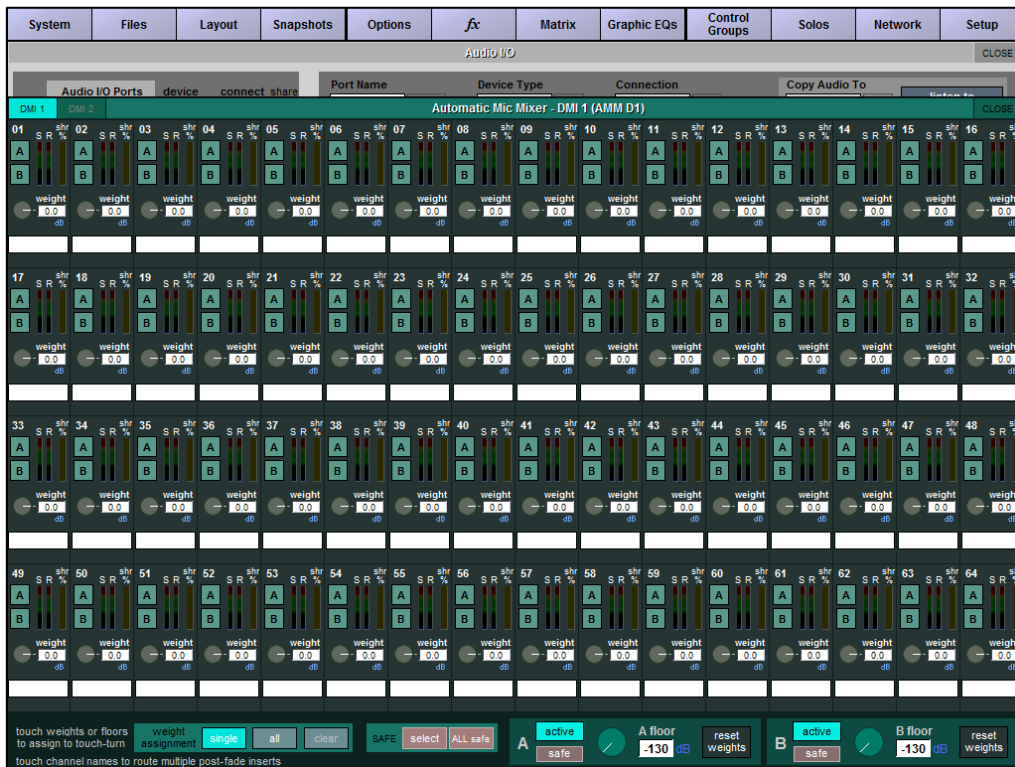

Figure 1: AMM Control Window

Each of the 64 slots within the AMM control panel include a group assign (Group A & Group B) and a weight control. The Floor control of each group imposes a lower limit on the level detector for all microphones assigned to that group, this prevents a noisy microphone from receiving a disproportionate share of gain. The Floor should be left at the default value of -130dB for normal operation.

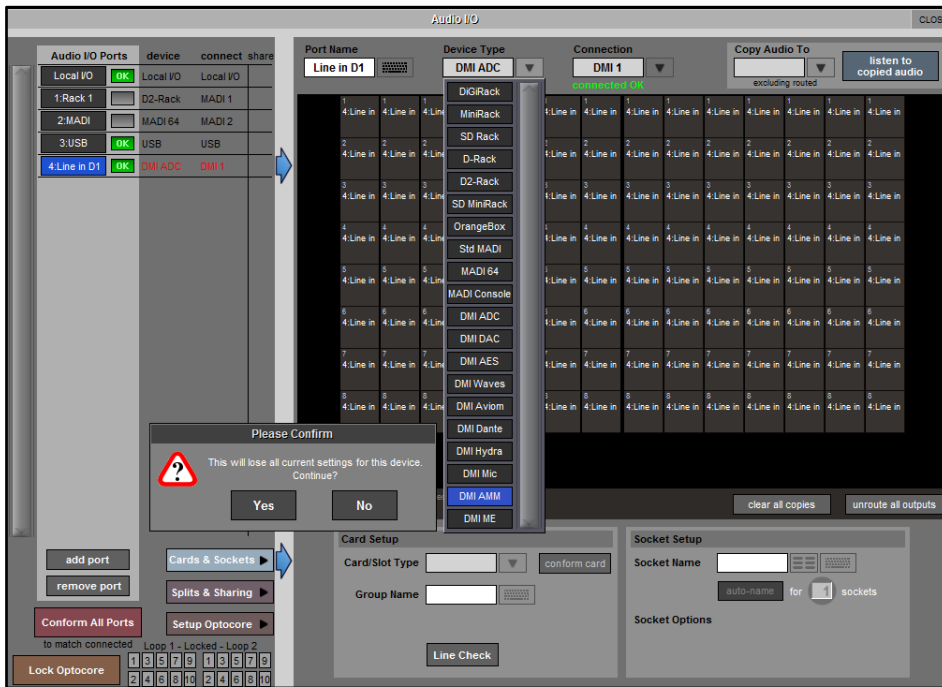

Figure 2: Conform AMM

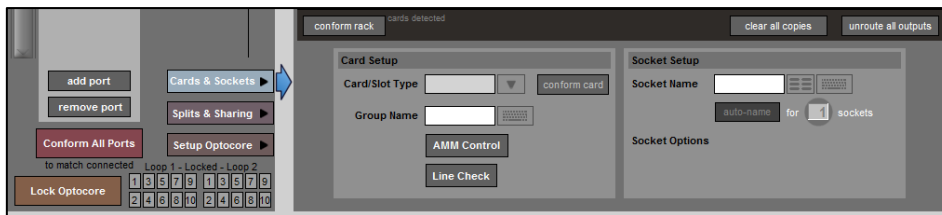

Figure 3: Open AMM Control

There are two ways to route channels to the AMM. The first is from within the AMM Control window itself. Touch the white box below each of the slots, this will open the AMM Routing window (Figure 4). Here you can ripple route channels to the AMM, using touch turn to select the desired number of channels. The AMM is automatically assigned a post-fader Insert B. Therefore, AMM can also be assigned in a way that DiGiCo users will be more familiar with, via the Insert B routing window at the bottom of a channel strip (Figure 5).

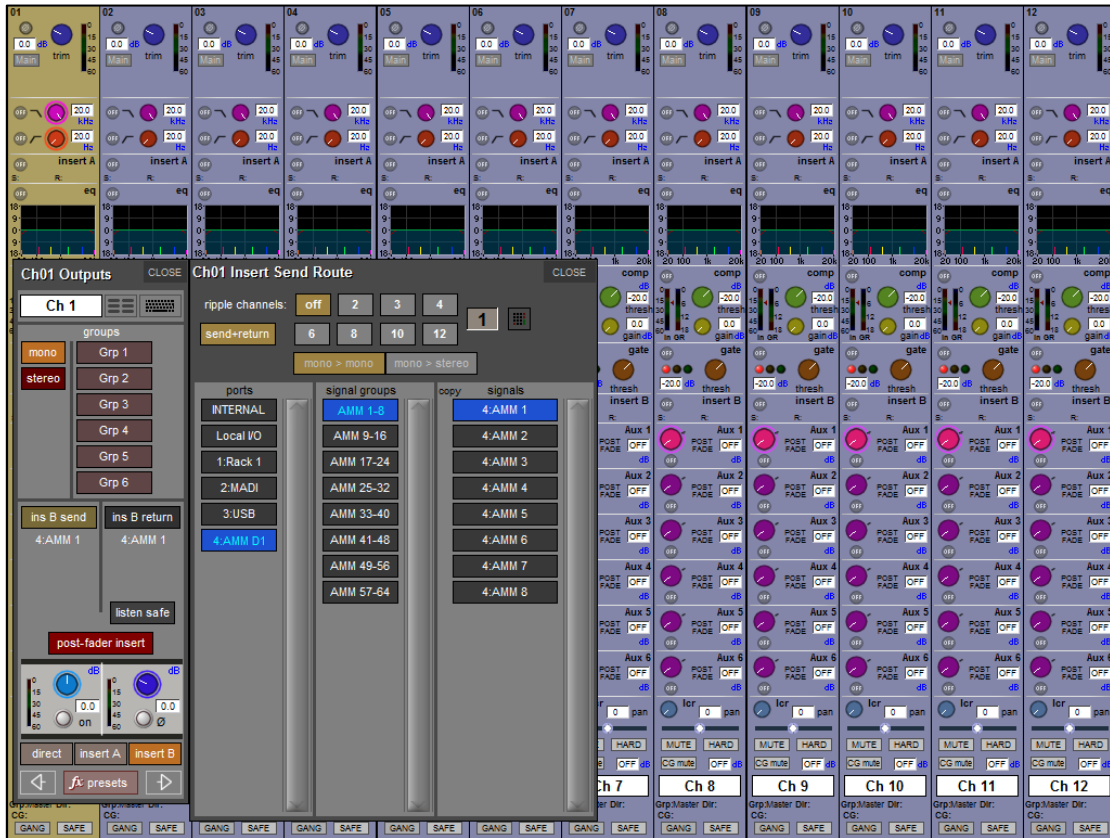

Figure 4: Routing Within AMM Control

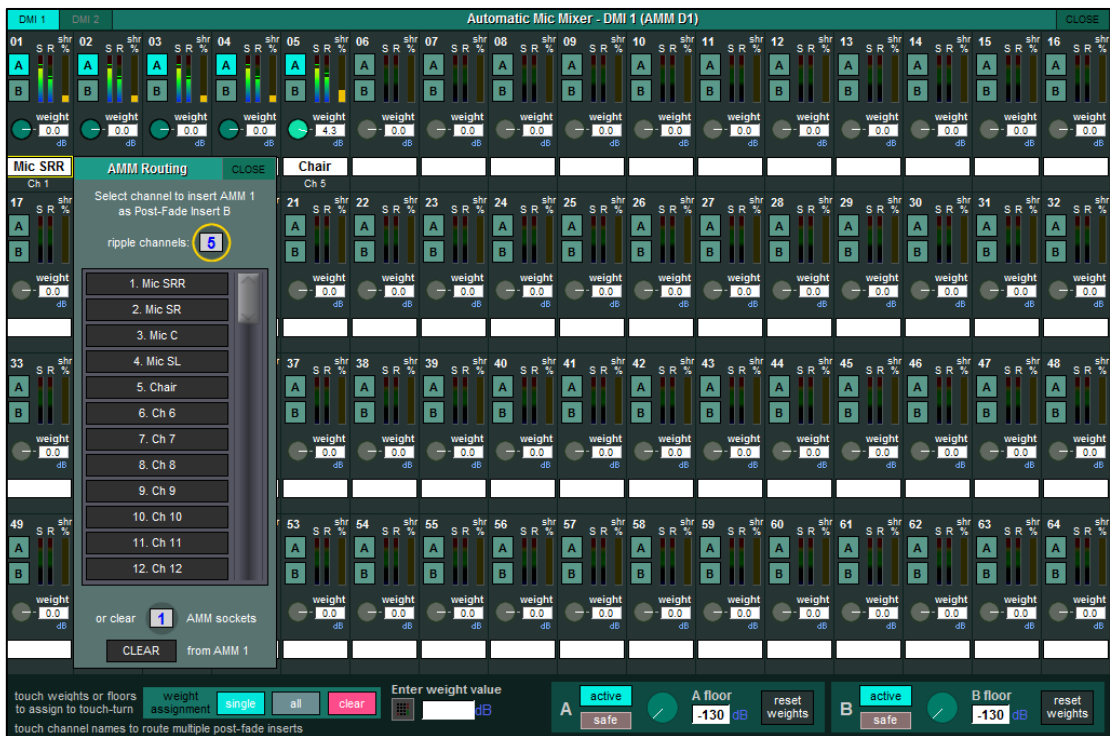

Figure 5: Routing via Insert B Routing Menu

When channels are routed to the AMM and assigned to a group, a **Share %** bar is seen in yellow on the right side of an AMM slot. This represents the gain Share that the channel is getting when the AMM is active. This meter is shown in terms of percentage, meaning that if 2 speakers stop talking at the same time then they will both get 50% of the gain share. The Weight control allows adjustment of the relative sensitivity on a per channel basis. When weighting controls are balanced (equal), each microphone has an equal opportunity to “take over” the system. Changing the weight will not have an effect on the overall level of the channel, just how easily it can take a share of the gain. Adding weight to one primary microphone ensure that the particular microphone (e.g. a chairperson) will get more of the share of gain (**Figure 6**).

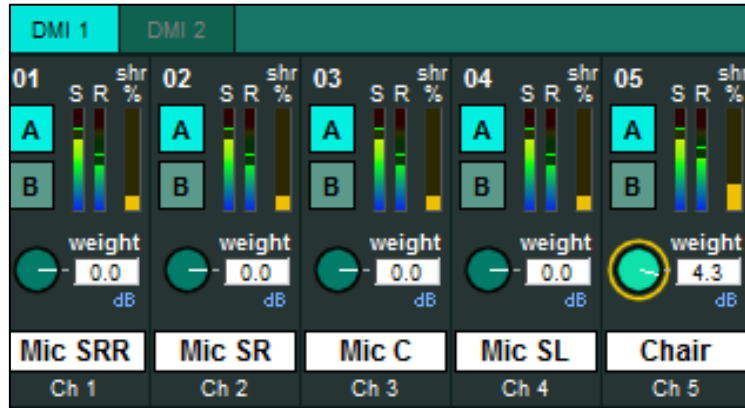

Figure 6: AMM Share Percentage and Weights

There are a set of master controls available at the bottom of the AMM Control window. These include a Floor control for each AMM group within the card and a safe control. The Floor control imposes a lower limit on the level detector for all microphones assigned to the relevant AMM group. This prevents a noisy microphone from receiving a disproportionate share of gain. The Floor should be left at the default value of -130dB for normal operation. The safe option excludes these floor controls from snapshots.

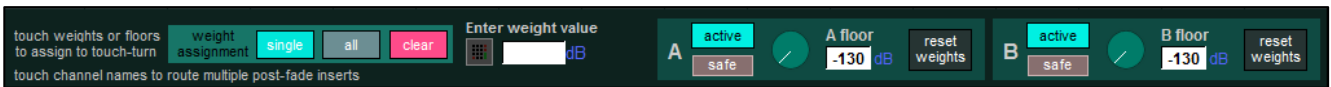

Figure 7: AMM Master Controls

All AMM parameters (both master and channel specific) are saved on a per snapshot basis and can be saved or removed from the global scope. Only input channels can be added to the AMM. It can be saved globally via the Input Devices option in the Global Scope menu on the Snapshots window. This is **NOT** enabled by default.

Global Snapshot Scope														CLOSE
channel types	input/trim	delay	filters	eq	dynamics	inserts	sends	fader	mute	panner	to groups	outputs	external	
	recall	update	recall	update	recall	update	recall	update	recall	update	recall	update	recall	update
Input devices	✗	✗												
Input Channels	✓	✓	✓	✓	✓	✓	✓	✓	✓	✓	✓	✓	✓	✓
Aux Outputs	✓	✓	✓	✓	✓	✓	✓	✓	✓	✓		✓	✓	✓
Group Outputs	✓	✓	✓	✓	✓	✓	✓	✓	✓	✓	✓	✓	✓	✓
Control Groups								✓	✓	✓				
FX	✓	✓												
Matrix Inputs	✓	✓					✓	✓						
Matrix Outputs	✓	✓	✓	✓	✓	✓	✓	✓	✓	✓		✓	✓	
Graphic EQ				✓	✓									
Nodal Processing				✓	✓	✓	✓							
Spice Rack						✓	✓							
Output devices												✓	✓	

snapshot recalls TOTAL gain ✗ midi ☺ ✓ gpo relays ☹ ✓

Figure 8: Global Scope > Input Devices

2.8 DMI-KLANG

With the DMI-KLANG card, 64 signals can be routed to the card and up to 16 immersive monitor mixes plus solo routed back to the console. The DMI card can be configured in the KLANG Control panel, found under the **Cards & Sockets** tab of the card's port in **Audio I/O**.

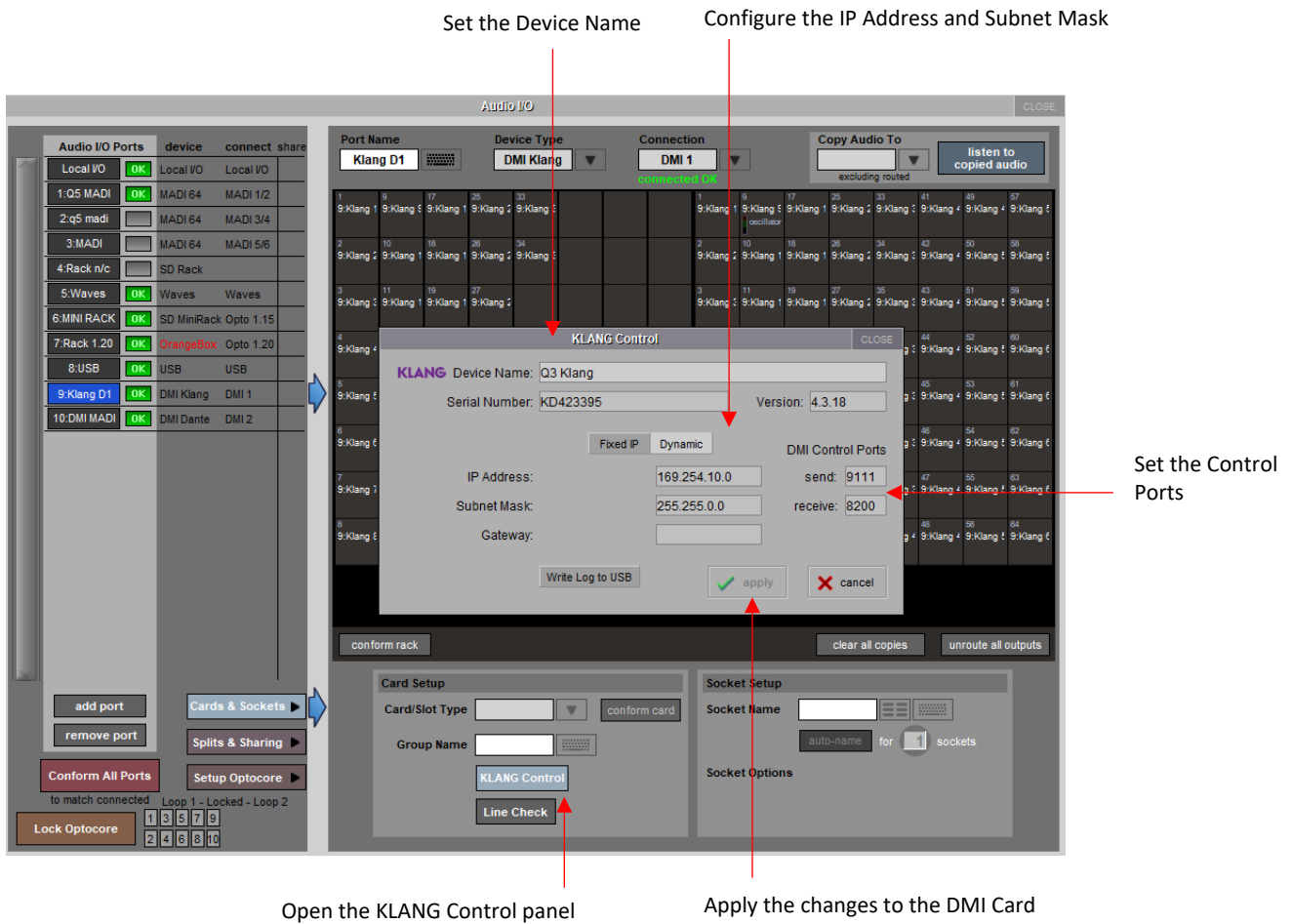

The DMI-KLANG card can be controlled from the console after being connected to the consoles network and setup in the **External Control** panel.

2.9 DMI-Dante 64@96 & Dante IO Control

PLEASE NOTE that for the connection and use of the A168D & A164D Dante IO boxes, there is a requirement for the following firmware updates to the Dante 64@96 DMI card:

1. *DMI Dante 64@96 firmware update (v103) which is included in the update package.*
2. *A Dante firmware update (4.0.19) for the DMI card which can be updated using Dante Updater in Dante Controller.*

Socket parameters on A168D and A164D IO racks can be controlled in the same way as other DiGiCo I/O racks when connected to a Dante 64@96 DMI card and routed in Audinate’s “Dante Controller” software.

With a DMI Dante 64@96 card installed in a console, access to 64 channels of IO to/from the Dante network is provided. A Dante IO box can provide a specific number of IO on the Dante network according to the rack’s capability.
168D = 16 analogue In and 8 Analogue Out

Any Dante network may have many more devices on it than just a single console and rack. There might be multiple Dante equipped consoles, multiple racks and other Dante devices. When a console has a DMI Dante fitted, it “sees” that DMI as a 64 channel interface device to/from the Dante network. The source device of the audio signals it is receiving across that interface and the destination device of any signals that it is sending out across that interface are generally “unknown” to the console.

The critical component in determining where the audio is going to/from is the Dante network controller which is responsible for setting up audio paths (routing) on the network.

As an example, using just a single console and a single rack, the console could use its DMI Dante channel 1 as an input signal to its own console Input Channel 1 but the audio signal which appeared on that DMI Dante channel could be any signal from the Dante IO rack and is determined by the routing in the Dante Controller.

With the following routing in place, a console that selects any of the DMI card channels 1-16 as an input source will receive the signal from the same numbered Rack Input socket – this is a logical setup.

A168D Rack is a Transmitter in this case.
Each of the 16 Rack input sockets are routed to the same numbered DMI 64@96 channel



Network Switch

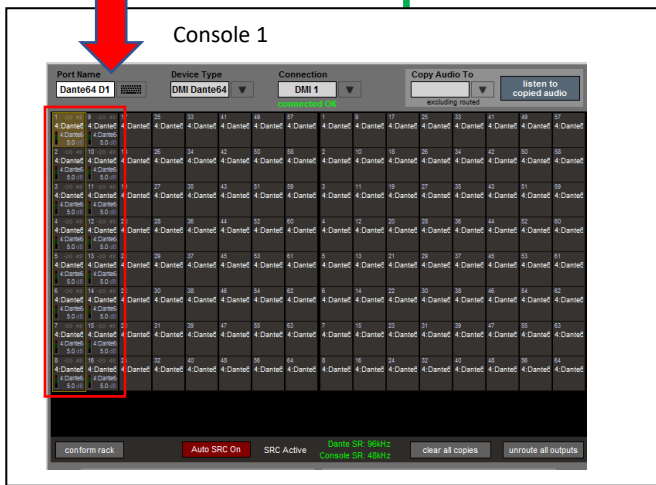

DMI 64@96 is a Receiver in this case.
Each channel receives the same numbered input socket from the rack.

In this example, a console that routes signal to DMI card output channels 1-8 will be sending them to the same numbered Rack Output socket.

Console 1 DMI is a Transmitter in this case.
Each of the DMI 64@96 outputs 1-8 are routed to same numbered Rack output sockets

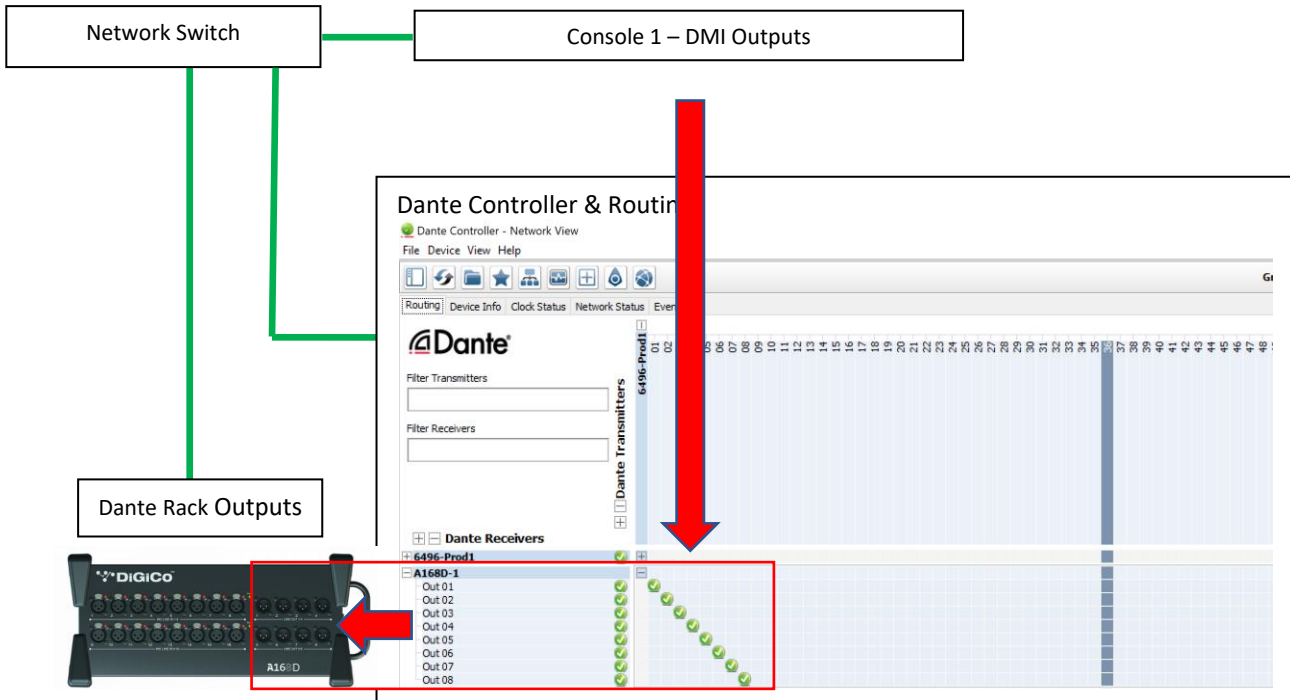

Quantum Home

When the Master screen > System > Quit To Windows button is pressed, the console application is closed and the Quantum Home interface can be used to adjust various system settings.

When the system is locked, Quantum Home automatically launches the Quantum 2 application on start-up. When unlocked, the system can be configured.

3.1 Main Shortcuts

- **Quantum 2:** launches the Quantum 2 application.
- **Quantum Upgrade:** launches the Quantum Upgrade application.
- **Network Settings:** see section on network settings.
- **Quantum Test:** launches the Quantum Test application.

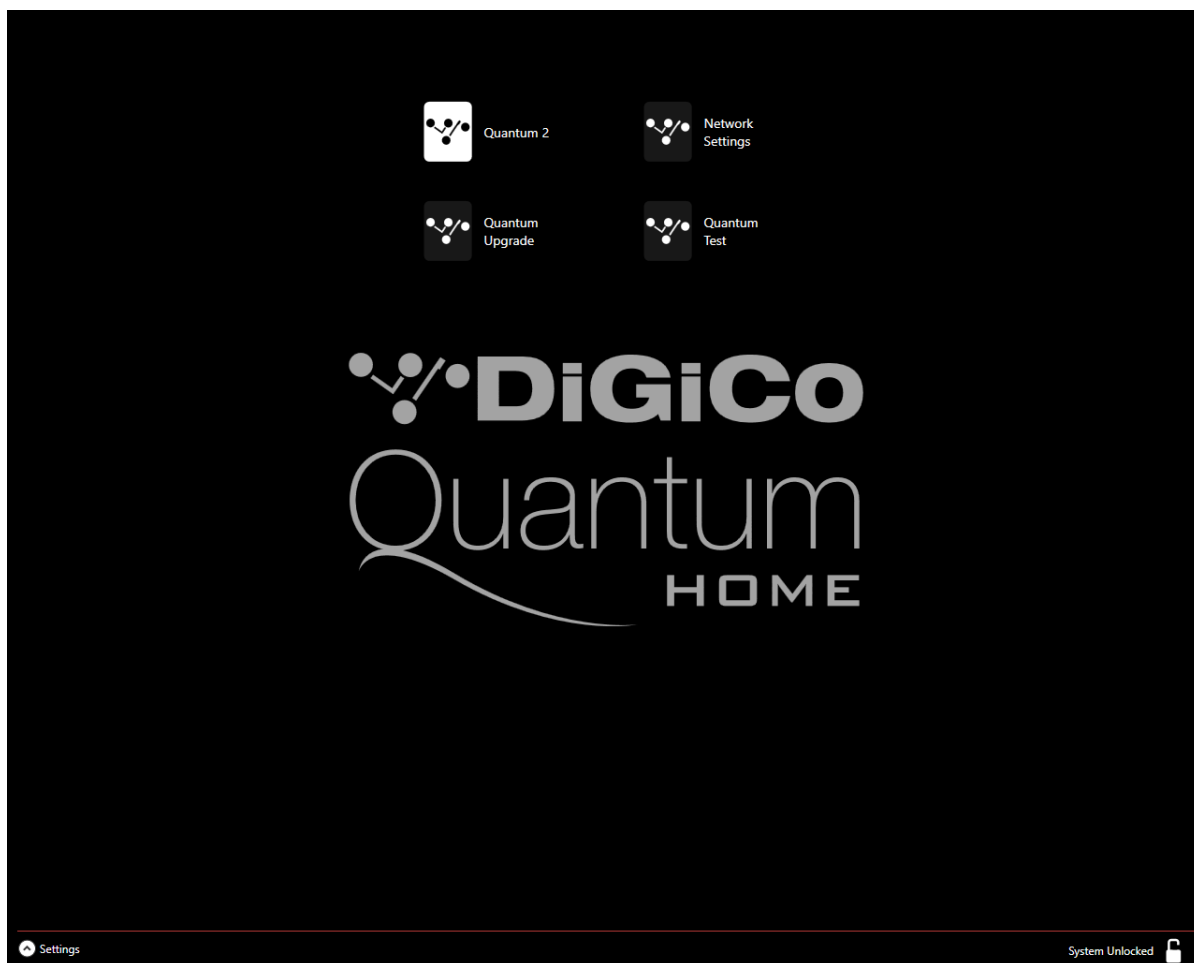

3.2 Settings Pane

Click the bottom Settings pane to expand it.

- **File Browser:** opens a standard File Explorer
- **Delete Startup Sessions:** deletes the following start-up files:
 - "D:\Quantum2\startup.ses"
 - "D:\Quantum2_session.ses"
- **Show All Windows:** restores all open windows that have been minimised.
- **System Information:** see section on system information.
- **Advanced Settings:** see section on advanced settings.
- **Power:** opens a window with three buttons:
 - **Power Off:** turns the console PC off.
 - **Restart:** reboots the console PC (does not reboot the engine or work-surfaces).
 - **Cancel:** closes the Power windows and returns to the main Quantum Home view.

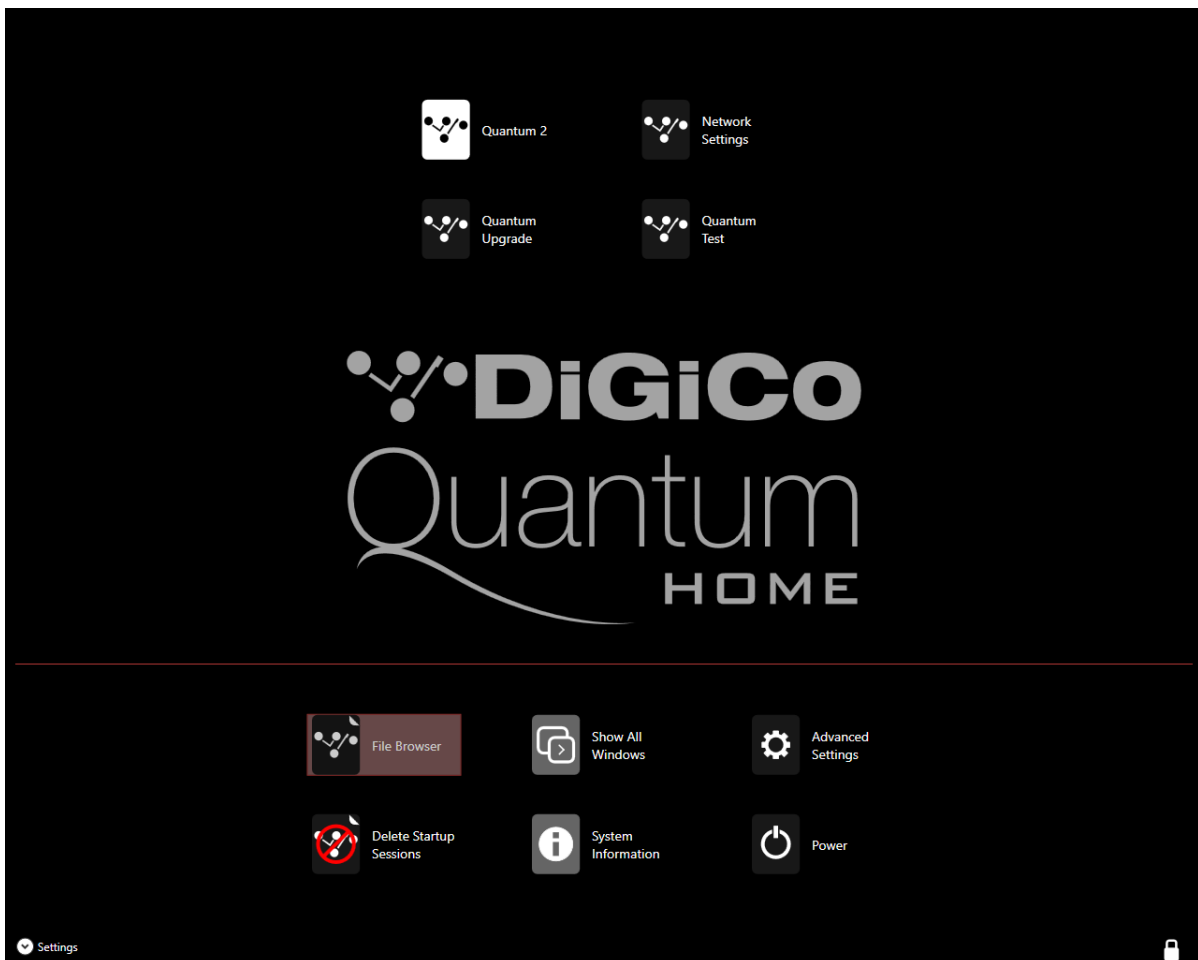

3.3 System Information

Opens a window displaying general information about the system:

- **General:**
 - **PC Name:** name of the console PC – the factory default name should contain the serial number of the console.
 - **IP Address:** static IP address of the console PC.
 - **App Version:** version number of the Quantum 2 application.
 - **Home Version:** version number of Quantum Home.
 - **System Version:** version number of the overall system.
- **Disks:**
 - **C Drive:** amount of free disk space on the C:\ drive.
 - **D Drive:** amount of free disk space on the D:\ drive.
 - **Memory:** amount of RAM on the console PC.
- **BIOS:**
 - **BIOS:** version number of the console PC's BIOS.
 - **Firmware:** version number of the console PC's board controller firmware.
- **Save to File:** click to save the system information to a text file. The saved file also contains the “locked/unlocked” state of the PC and a timestamp.

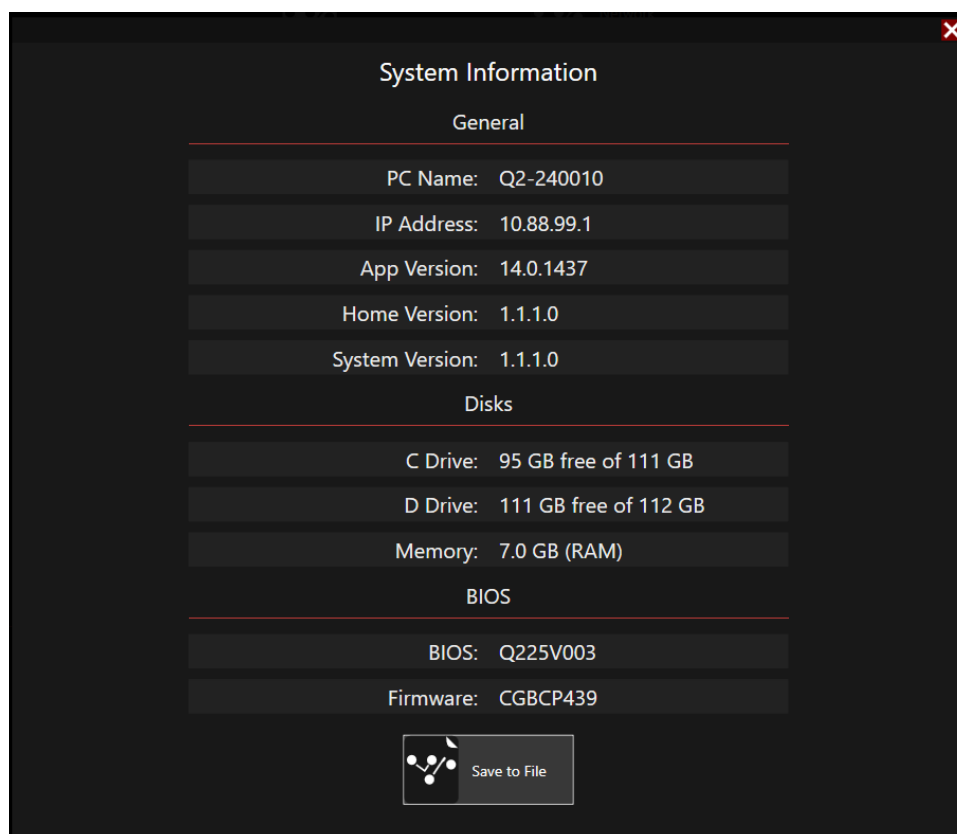

3.4 Advanced Settings

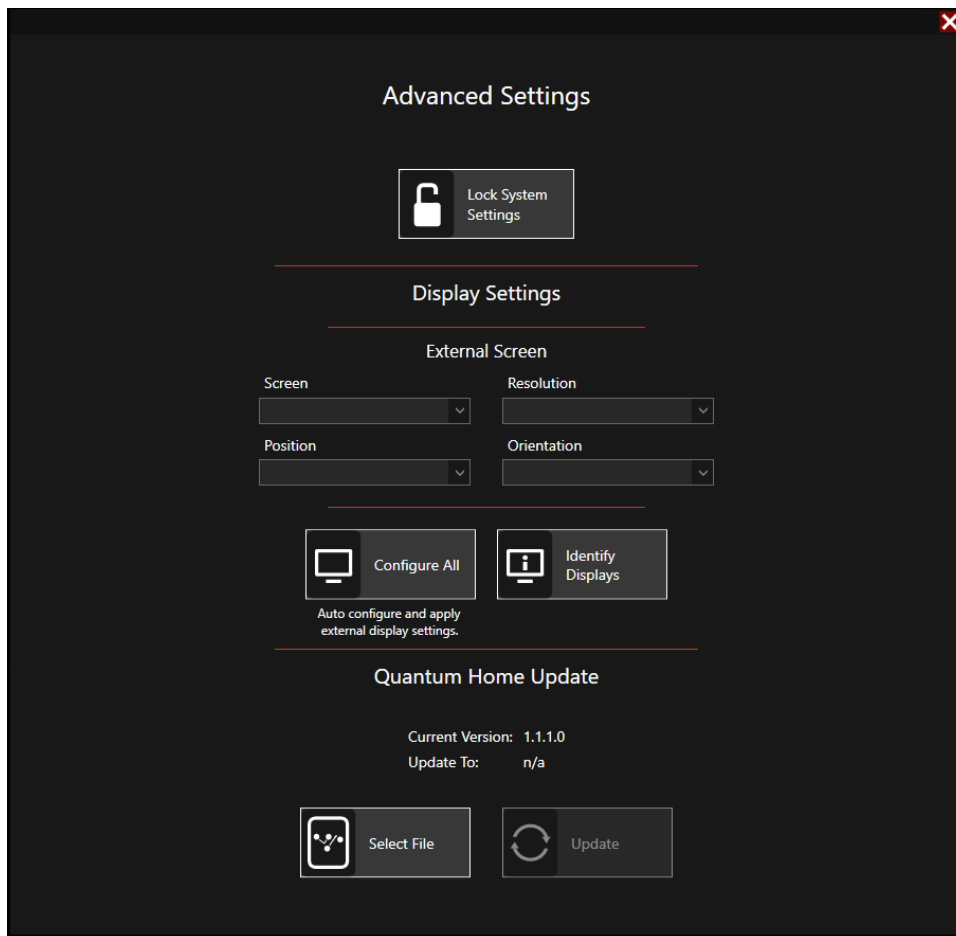

- **Lock System Settings/Unlock System Settings:** locks/unlocks the system and triggers a console PC reboot.
 - **Locked state:** this is the “console mode” in which Quantum Home automatically launches the Quantum 2 application at start-up.
 - **Unlocked state:** “configuration mode” in which advanced settings and network settings are enabled.
- **Display Settings:**
 - **External Screen:** settings for the external monitor.
 - **Resolution:** drop-down list of available screen resolutions for the external screen.
 - **Orientation:** drop-down list of screen orientations:
 - Landscape.
 - Portrait.
 - Landscape (inverted).
 - Portrait (inverted).
 - Disconnected: disables the external screen.
 - **Position:** drop-down list of available positions for external screen
 - Left screen (acts as a channel view for the left fader bank, the screen follows bank selection).
 - Overview (acts as an external overview screen).
 - **Configure All:** applies the external screen settings and reconfigures the master, left and right screens. Once configured, Quantum Home identifies the screens, allowing for a visual confirmation of the new display configuration.

Note that Quantum Home will require a restart after displays configuration, either by locking and rebooting the console or by a forced restart of Quantum Home when exiting the Advanced Settings menu.

- **Identify Displays:** pops up the display identification view on each screen highlighting the current screen position.

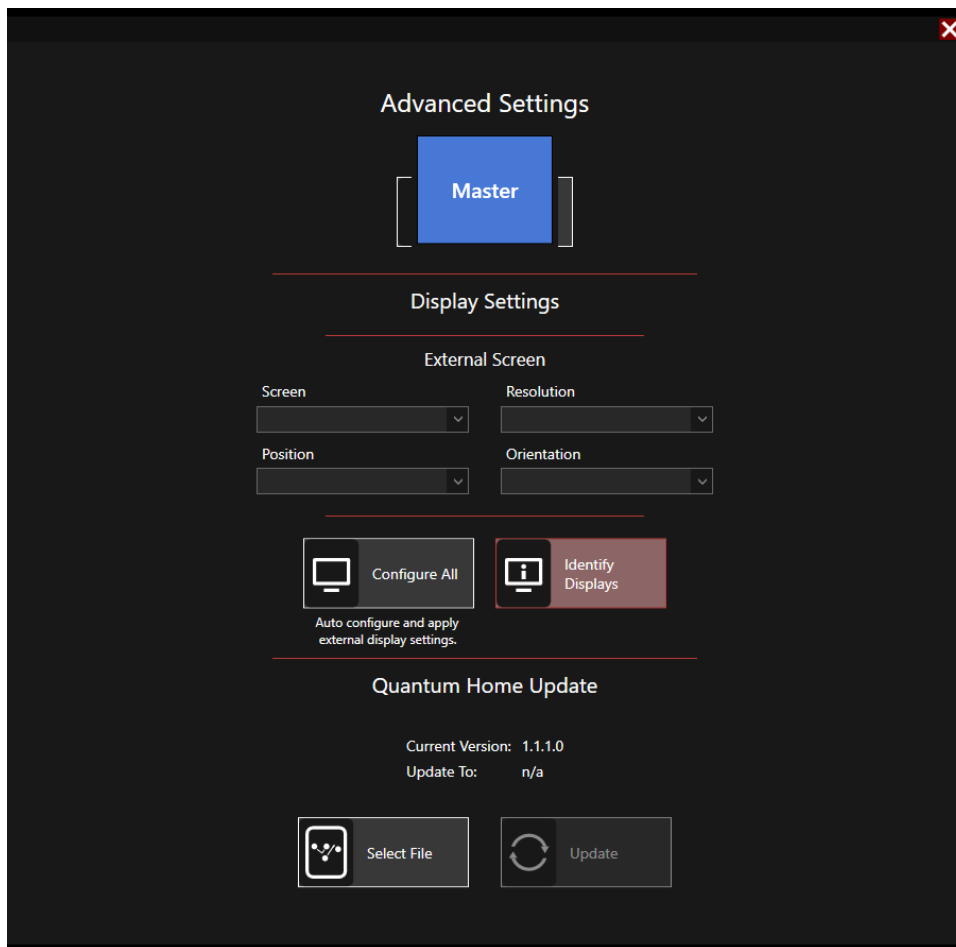

Note: To switch between left and Overview screen as selections for the external screen, first unlock the system settings, and wait for the console to reboot, then switch the position in: display settings> external screen> position and then press configure all, this should display the new position of the screens relative to the master screen and lock and restart the console.

- **Quantum Home Update:**
 - **Select File:** opens a file dialog window to browse and open a new QuantumHome.exe file.
 - **Update:** applies the update by replacing the current Quantum Home with the selected file. Triggers a restart of Quantum Home.

3.5 Network Settings

Requires the system to be unlocked to apply new setting. If the system is locked, the current settings are displayed but cannot be changed.

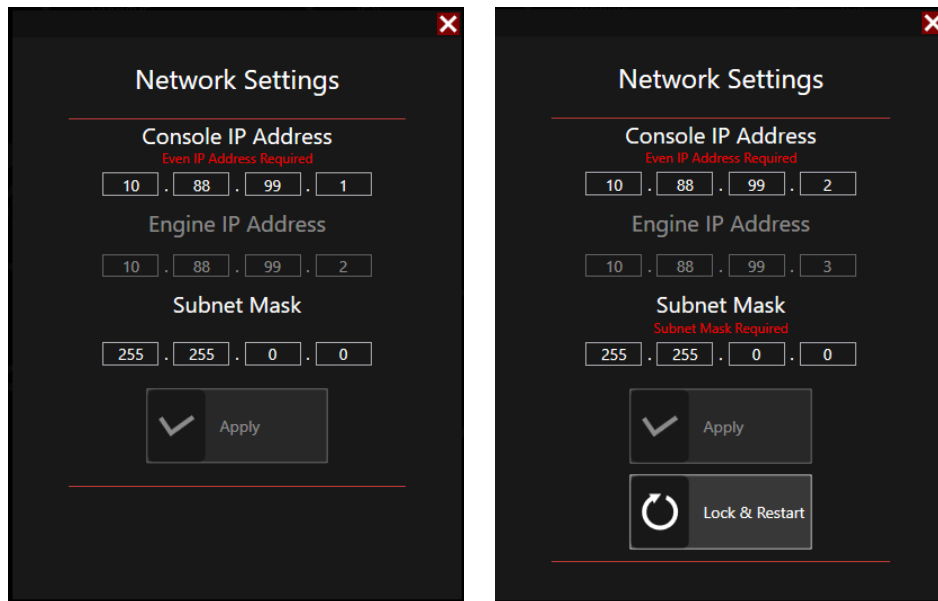

- **Console IP Address:** shows the current IP address of the console, can be edited to apply a new console IP address.
- **Engine IP Address:** queries and shows the current engine IP address. When the console IP address is edited, the displayed engine IP address changes accordingly. This is because the console and engine IP addresses are required to be consecutive.
- **Subnet Mask:** shows the current subnet mask of the console, can be edited to apply a new console subnet mask.
- **Apply:** applies the network settings (console and engine IP addresses and subnet mask).
- **Lock & Restart:** is enabled after network settings have been applied. Causes the console PC to restart and locks the system.

3.6 Keyboard Shortcuts

- Hold **"Space"** at start-up: boots to Quantum Home without launching the Quantum 2 application.